

Panasonic®

Operating Instructions



5.8 GHz Expandable
Digital Cordless Phone System

Model No. **KX-TG4500**

4LINE



This unit is compatible with Caller ID. To use this feature you must subscribe to the appropriate service offered by your service provider.

Charge the cordless handset battery for 7 hours before initial use.

Please read these Operating Instructions before using the unit and save them for future reference.

For assistance, visit our website:

<http://www.panasonic.com/phonehelp> for customers in the U.S.A. or Puerto Rico.

Table of Contents

Introduction

Accessory information	5
Expanding your phone	6
Important safety instructions	7
For best performance	9
System capabilities	10

Preparation

Installation	11
Installing the backup battery in the base unit	11
Connecting the base unit handset and AC adaptor	12
Connecting the line cords	13
Connecting the AC adaptor to the charger	15
If you subscribe to a DSL service	15
Installing the battery in the cordless handset	16
Battery charge	16
Controls and display	18
Controls	18
Using softkeys and navigation keys	21
Displays	23
Setting-up the unit before use	24
Setting the date and time	24
Setting the display language	24
Selecting the line mode	25
Selecting the dialing mode	25
Registering additional cordless handsets	25

Making/Answering Calls

Making calls	28
Answering calls	32
Using additional lines during a conversation	34
Intercom	35
Making an intercom call	35
Answering intercom calls	35
Transferring a call	36
Placing a call on hold	37
Swapping between two external calls	37
Conference calls	38
Useful features during a call	39
Joining in a conversation	39
Call privacy	39
Recording a conversation	40
Muting your conversation	40
Using the PAUSE key (for PBX line or long distance calls)	41
Using the FLASH key	41

For call waiting service users	41
Temporary tone dialing	42

Phonebook

Using the Phonebook	43
Storing names and numbers in the Phonebook	43
Finding and calling a Phonebook item	44
Editing Phonebook items	45
Erasing Phonebook items	46
Chain dial	46

Caller ID Service

Using caller ID service	47
Caller list	48
Viewing and calling back using the caller list	48
Editing a caller's phone number before calling back	49
Storing caller information in the Phonebook	50
Erasing caller information	50

Voice Mail System

Voice Mail System	51
Setting the mailbox password	51
Listening to messages from the base unit	52
Listening to messages with the cordless handset	55
Creating and sending messages	57
Transferring a call to a personal mailbox	58
Checking the remaining recording time and number of messages	59
Erasing all messages stored in a mailbox	59
User greetings	60
Personal greetings	60
Turning the cordless handset answer mode on or off	62

Remote access

Remote access	63
Accessing the voice mail system remotely	63

Automated Attendant System

Automated Attendant System	66
How the Automated Attendant System works	66

Setting the Automated Attendant System	67	Erasing the current music on hold	90
Call transfer status	69	Other options	90
Call operator status	70	Selecting key tone	90
Answering System		Adjusting the time automatically	90
Setting the Answering System	71	Re-registering a cordless handset with the base unit	90
Turning on the Answering System	71	Storing speed dial numbers	91
Defining the number of rings	71	Customer support	92
Selecting the pre-recorded greeting message	72	Programming with direct commands	93
Recording a greeting message	72	Using direct commands on the base unit	93
Selecting a greeting message	72	Using mailbox direct commands on the base unit	94
Changing a recorded message	72	Using direct commands on the cordless handset	95
Erasing a greeting message	73		
Turning off the Answering System	73	Useful Information	
Programmable Settings		Wall mounting the charger	96
Guide to programming	74	Cordless handset rechargeable battery replacement	97
Base programming	74	Backup battery replacement	97
Cordless handset programming	76	Headset (optional)	98
Initializing base unit and cordless handset(s)	77	Belt clip	99
Clearing settings	77	Reset button	100
Clearing the Caller List	78	Adding another phone	100
Clearing the Phonebook	78	Error messages	101
Clearing the redial list	79	Display messages	101
Erasing messages	79	Voice messages	103
Ringer settings	80	Troubleshooting	104
Selecting the ringer volume	80	General use	104
Selecting the ringer pattern	80	Programmable settings	105
Call options	81	Making/answering calls, paging	105
Auto talk	81	Phonebook	106
Caller ID edit	82	Caller ID	107
Setting up ring groups	82	Recharging the battery (cordless handset)	108
Display options	83	Voice mail system/automated attendant system/answering system	109
Adjusting the LCD contrast	83	Frequently asked questions	110
Changing the name of the cordless handset	83	The base unit	110
Telephone settings	84	The cordless handset	110
Selecting the flash time	84	Messages and voice mail	111
Line selection for outgoing calls	84	Calls	112
Setting up the telephone line	85	Lines	112
Restricting calls	85	FCC and other information	113
Message alert	86	Specifications	116
Call screening (monitoring)	86	Warranty	117
Notify alert	86	Customer services	119
Automatically deleting messages	88		
Checking the remaining recording time and number of messages	88	Index	
Music on hold	88	Index	120
Turning the music on hold feature on or off	88		
Recording music on hold	89		

Introduction

Thank you for purchasing your new Panasonic cordless phone system.

We recommend keeping a record of the following information for future reference.

Serial No.¹

Date of purchase

Name and address of dealer

1. The serial number can be found on the bottom of the unit.

Caller ID and Call Waiting Service, where available, are telephone service provider services. After subscribing to Caller ID, this phone will display a caller's name and phone number. Call Waiting Caller ID, which displays a second caller's name and phone number while the user is engaged in another call, requires a subscription to both Caller ID and Call Waiting with Caller ID services (CWID).

Attach your purchase receipt here.

Accessory information

Included accessories

To order replacement accessories, call 1-800-332-5368.

TTY users (hearing or speech impaired users) can call 1-866-605-1277.

No.	Accessory items	Order number	Quantity
1	AC adaptor (for base unit and charger)	PQLV256Z	2
2	Base unit handset	PQJXF0201Z	1
3	Cordless handset battery	HHR-P104	1
4	Cordless handset battery cover	PQYNTG4500BR	1
5	4-wire telephone line cord	PQJA10088Z	2
6	Backup battery	HHR-P516	1
7	Audio cable	PQJA10165Z	1
8	Charger	PQLV30046ZA	1
9	Handset cord	PQJA212V	1
10	Belt clip	PQKE10377Z5	1

1

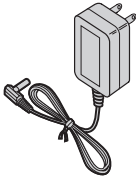

2

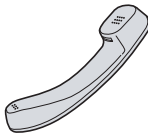

3

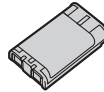

4



5



6

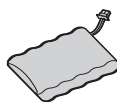

7



8

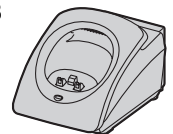

9

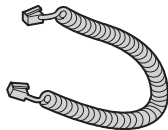

10

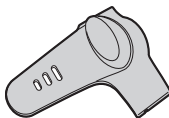

Expanding your phone

KX-TG4500 includes one cordless handset and one base unit.



KX-TG4500



KX-TGA450

The system can be expanded by adding up to seven accessory cordless handsets, sold separately.

A maximum of eight cordless handsets can be registered to the base unit.

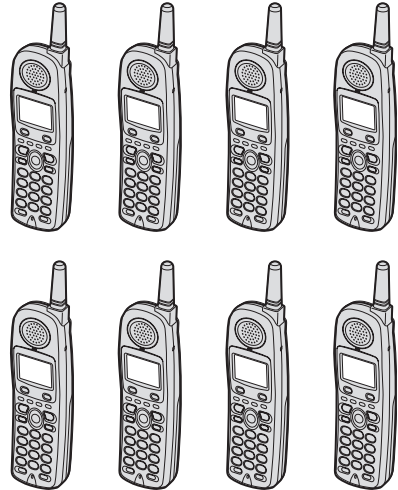

The included cordless handset is pre-registered at the factory, and assigned an extension number of 1.

After purchasing accessory cordless handsets, you must register each to the base unit.

The model number of the accessory cordless handset is KX-TGA450.

A charger unit is included with each accessory cordless handset.

To order accessory cordless handsets, contact your dealer or call 1-800-211-PANA (1-800-211-7262) to locate a dealer.

(Please read the accessory cordless handset's Installation Manual for more information).

Important safety instructions

When using this unit, basic safety precautions should always be followed to reduce the risk of fire, electric shock, or personal injury.

1. Read and understand all instructions.
2. Follow all warnings and instructions marked on this unit.
3. Unplug this unit from power outlets before cleaning. Do not use liquid or aerosol cleaners. Use a damp cloth for cleaning.
4. Do not use this unit near water, for example near a bathtub, wash bowl, or kitchen sink.
5. Place the unit securely on a stable surface. Serious damage and/or injury may result if the unit falls.
6. Do not cover slots and openings on the unit. They are provided for ventilation and protection against overheating. Never place the unit near radiators, or in a place where proper ventilation is not provided.
7. This equipment should only be connected to a power supply as described on the unit. If you are not sure of the type of power supplied to your home, consult your dealer or local power company.
8. Do not place objects on the power cord. Install the unit where no one can step or trip on the cord.
9. Do not overload power outlets or extension cords. This can result in the risk of fire or electric shock.
10. Never push any objects through slots in this unit. This may result in the risk of fire or electric shock. Never spill any liquid on the unit.
11. To reduce the risk of electric shock, do not disassemble this unit. Take the unit to an authorized service center when service is required. Opening or removing covers may expose you to dangerous voltages or other risks.
12. Unplug this unit from power outlets and refer servicing to an authorized service center when the following conditions occur:
 - A. When the power cord is damaged or frayed.
 - B. If liquid has been spilled into the unit.
 - C. If the unit has been exposed to rain or water.
 - D. If the unit does not work normally by following the operating instructions. Adjust only controls covered by the operating instructions. Improper adjustment may require extensive work by an authorized service center.
 - E. If the unit has been dropped or physically damaged.
 - F. If the unit exhibits a distinct change in performance.
13. Avoid using telephones during thunderstorms, except cordless types. There may be a remote risk of an electric shock from lightning.
14. Do not use this unit to report a gas leak when in the vicinity of the leak.

SAVE THESE INSTRUCTIONS

CAUTION:

Installation

- Never install telephone wiring during a lightning storm.
- Never install telephone jacks in wet locations unless the jack is specifically designed for wet locations.
- Never touch uninsulated telephone wires or terminals unless the telephone line has been disconnected at the network interface.
- Use caution when installing or modifying telephone lines.
- Do not touch the plug with wet hands.
- The AC adaptor is used as the main disconnect device. Ensure that the AC outlet is installed near the unit and is easily accessible.
- When installing the base unit and cordless handset(s), ensure that antennas are not mounted in a position where they may cause injury. Particular care should be taken to ensure that antennas are not placed at eye level.

Battery

To reduce the risk of fire or injury to persons, read and follow these instructions.

- Use only the battery(ies) specified.
- Do not dispose of the battery(ies) in a fire. They may explode. Check with local waste management codes for special disposal instructions.
- Do not open or damage the battery(ies). Released electrolyte is corrosive and may cause burns or injury to the eyes or skin. The electrolyte may be toxic if swallowed.
- Exercise care when handling the battery(ies). Do not allow conductive materials such as rings, bracelets or keys to touch the battery(ies). This may cause a short circuit and the battery(ies) and/or the conductive material may overheat and cause burns.
- Charge the battery(ies) provided with or identified for use with this product only in accordance with the instructions and limitations specified in this manual.

WARNING:

- To prevent the risk of fire or electrical shock, do not expose this product to rain or any type of moisture.
- Unplug this unit from power outlets if it emits smoke, an abnormal smell or makes an unusual noise. These conditions can cause fire or electric shock. Confirm that smoke has stopped and contact the Panasonic Call Center at 1-800-211-PANA (1-800-211-7262).
- The base unit handset and cordless handset earpieces are magnetised and may retain small ferrous objects.

Medical

- Consult the manufacturer of any personal medical devices, such as pacemakers or hearing aids, to determine if they are adequately shielded from external RF (radio frequency) energy. The unit operates in the frequency range of 5.8 GHz and the power output level can range from 0.04 to 0.25 watts. Do not use the unit in health care facilities if any regulations posted in the area instruct you not to do so. Hospitals or health care facilities may be using equipment that could be sensitive to external RF (radio frequency) energy.

For best performance

Base unit location/noise

The base unit and cordless handset(s) use radio waves to communicate with each other.

For maximum distance and noise-free operation, we recommend the following:

- Placing the unit away from electrical appliances such as a TV, personal computer or another cordless phone.
- Placing the base unit in a HIGH and CENTRAL location with no obstructions such as walls.
- Raising the antenna vertically.
- If you use the cordless handset near a microwave oven which is being used, noise may be heard. Move away from the microwave oven and closer to the base unit.
- If you use the cordless handset near the base unit of another cordless phone, noise may be heard. Move away from the other base unit and closer to your base unit.

Environment

- Keep the unit away from electrical noise generating devices such as fluorescent lamps and motors.
- The unit should be kept free from excessive smoke, dust, high temperature, and vibration.
- The unit should not be exposed to direct sunlight.
- Do not place heavy objects on top of the unit.
- When you leave the unit unused for a long period of time unplug it from the power outlet.
- The unit should be kept away from heat sources such as heaters and kitchen stoves. It should not be placed in rooms where the temperature is less than 5 °C (41 °F) or greater than 40 °C (104 °F). Damp basements should also be avoided.
- The maximum calling distance may be shortened when the unit is used in the following places: near obstacles such as

hills, concrete walls, tunnels, subways, or near metal objects such as wire fences, etc.

- Operating near appliances operating near 5.8 GHz may cause interference. Move away from these electrical appliances.

Routine care

- Wipe the outer surface of the unit with a soft cloth. Do not use benzine, thinner, or any abrasive powder.

System capabilities

The unit can accommodate up to four external telephone lines, which are provided by a telephone service provider, or up to two intercom calls.

The capabilities of the unit can be expanded by registering up to eight cordless handsets at the base unit (page 25).

How many external calls and intercom calls can be conducted at one time?

The unit allows four simultaneous external calls with the base unit and three cordless handsets, or with four cordless handsets¹.

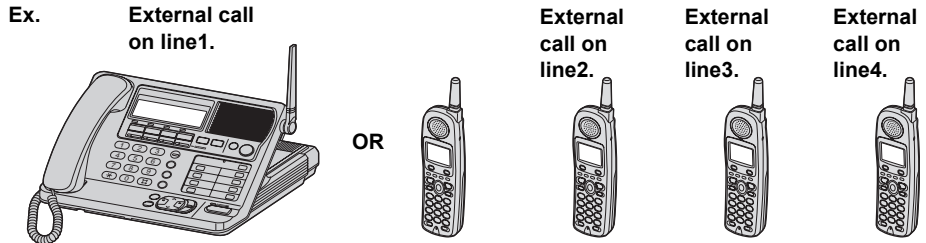

Two intercom calls can be conducted on four cordless handsets while the base unit simultaneously makes an external call. For example, two pairs of cordless handsets can be engaged in separate intercom calls while the base unit is engaged in an external call.

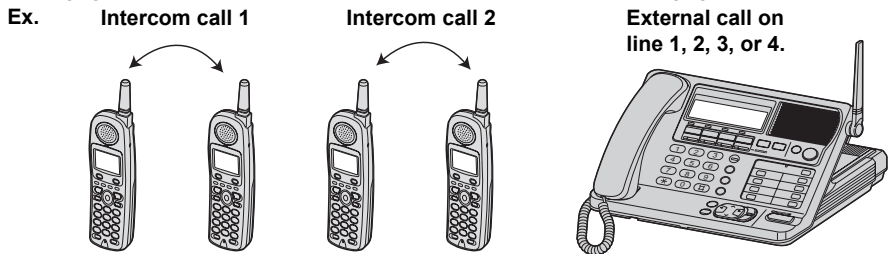

Up to three external calls can be conducted on cordless handsets or the base unit while a fourth cordless handset simultaneously conducts an intercom call with the base unit or another cordless handset. For example, the base unit and two cordless handsets can be engaged in separate external calls while two other cordless handsets can conduct an intercom call together.

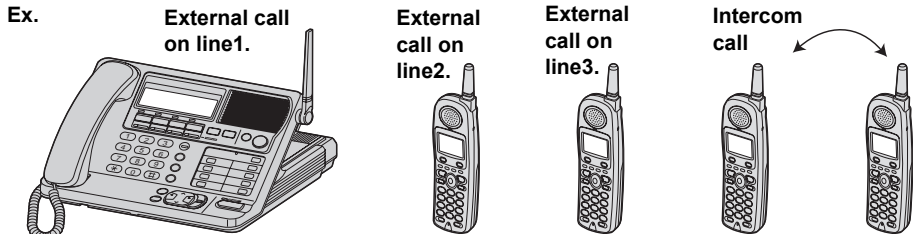

In the above three cases:

- All other cordless handsets are in the standby mode.

¹. The number of cordless handsets that can be used simultaneously will vary depending on the availability of external and internal calls, and the usage of mailboxes.

Installation

Installing the backup battery in the base unit

A rechargeable NiMH battery works as emergency power during a power failure. The fully charged backup battery provides the base unit with a minimum of 20 minutes operation. The battery is charged in the base unit while the AC adaptor is connected (page 12). It takes approximately 16 hours to charge fully.

- 1** Open the battery cover.

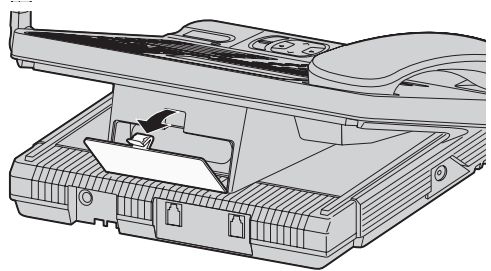

- 2** Install the backup battery in the battery compartment. Plug in battery connector as shown, and close the battery cover.

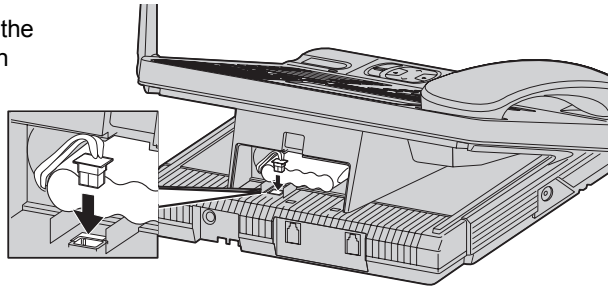

BATTERY indicator:

- The BATTERY indicator lights while the battery is being charged. (This is normal.)
- During a power failure (or if the AC adaptor is disconnected), the BATTERY indicator shows the battery strength:
 - Blinking slowly:** The unit is operating from the battery backup.
 - Blinking fast:** The battery is not connected, defective or non-chargeable.

BATTERY indicator

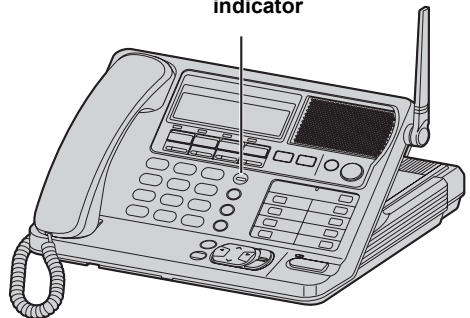

Note:

- The battery cannot be overcharged.
- If the backup battery has been discharged, the unit will not work during a power failure. If required, the unit can be replaced with a standard telephone to restore service during the power outage.

Connecting the base unit handset and AC adaptor

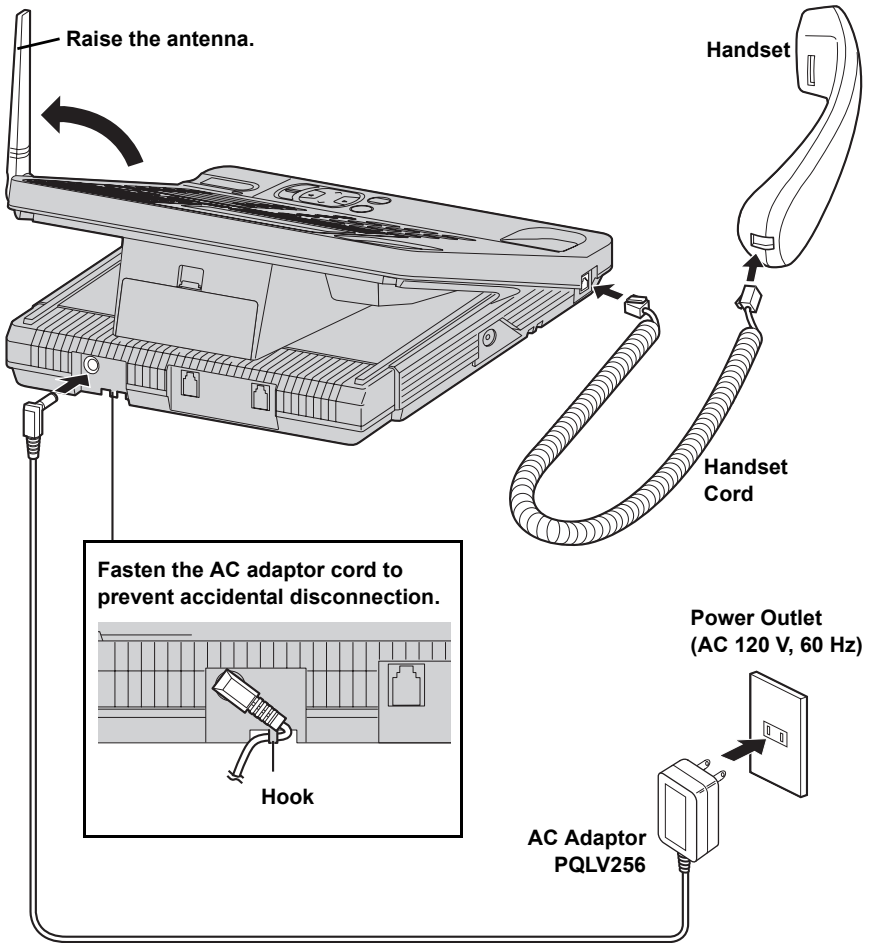

- Use only a Panasonic handset with the KX-TG4500.
- Use only the included Panasonic AC Adaptor PQLV256 (Order No. PQLV256Z).
- The AC adaptor must remain connected at all times. (It is normal for the adaptor to feel warm during use.)
- The AC adaptor should be connected to a vertically-oriented or floor-mounted AC outlet. Do not connect the AC adaptor to a ceiling-mounted AC outlet, as the weight of the adaptor may cause it to become disconnected.
- The BATTERY indicator lights while the AC adaptor is connected with the backup battery installed (page 11), this is normal.
- When placing the unit, care should be taken to place it so that the base unit antenna does not cause a danger. Particular care should be taken to ensure that the antenna is not placed at eye level or in a position that may pose a risk to people's eyes.

Connecting the line cords

Connect the telephone line cords to the base unit.

To connect two two-line telephone jacks

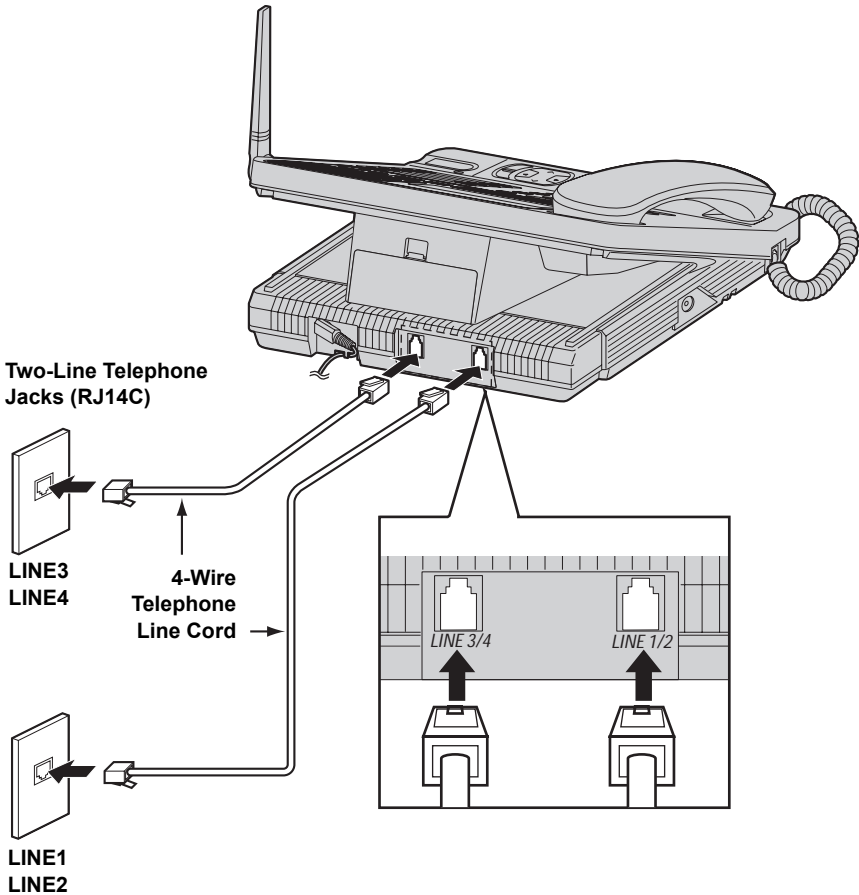

Preparation

To connect four single-line telephone jacks

For this connection, please purchase two 2-line adaptors (KX-J24) and two 2-wire telephone line cords (PQJA10088Z). To order, call the accessories telephone number shown on page 5.

Single-Line Telephone Jacks (RJ11C)

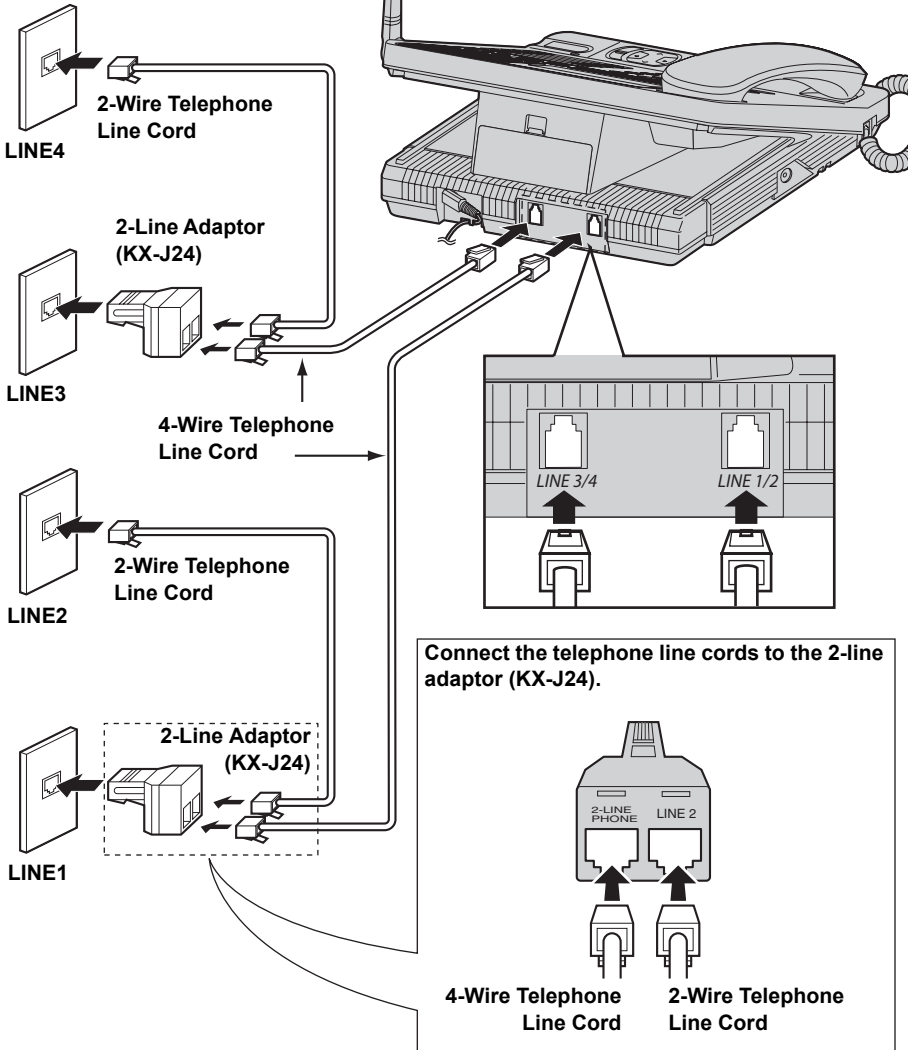

Connecting the AC adaptor to the charger

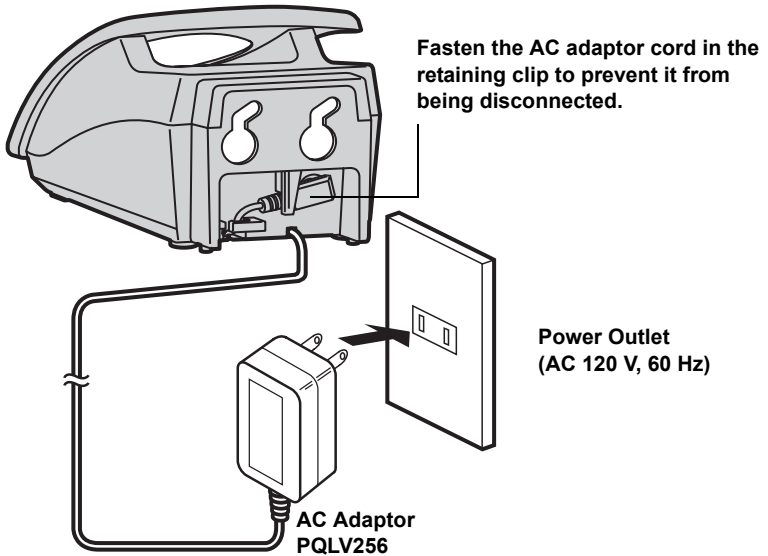

- Use only the included Panasonic AC ADAPTOR PQLV256 (Order No. PQLV256Z).
- The AC adaptor must remain connected at all times. (It is normal for the adaptor to feel warm during use.)
- The charger can be wall mounted, if required (page 96).

If you subscribe to a DSL service

- Please attach a noise filter (contact your DSL provider) to the telephone line between the base unit and the telephone line jack in the event of the following:
 - Noise is heard during conversations.
 - Caller ID features (page 47) do not function properly.

Preparation

Installing the battery in the cordless handset

- 1 Insert the battery, and press it down until it fits in position within the compartment.

Note:

- The end of the battery with the metal terminals should be inserted first and should be at the foot of the cordless handset.
- The flat side of the battery should fit against the inside of the battery compartment as shown.

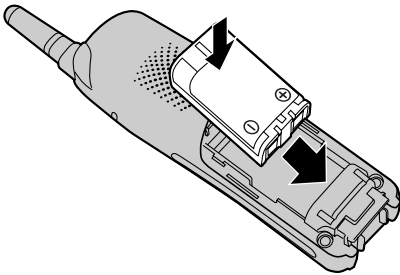

- 2 Close the cover.

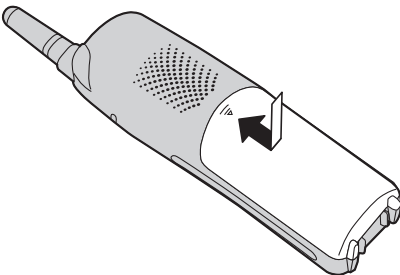

Battery charge

Place the cordless handset on the charger and charge for **7 hours** before initial use. Make sure that the cordless handset faces forward as shown.

- The CHARGE indicator will light, and “Charging” is displayed.
- When the battery is fully charged, “Charge completed” is displayed.
- A discharged battery may charge quickly and feel warm during the charging process. This is normal.

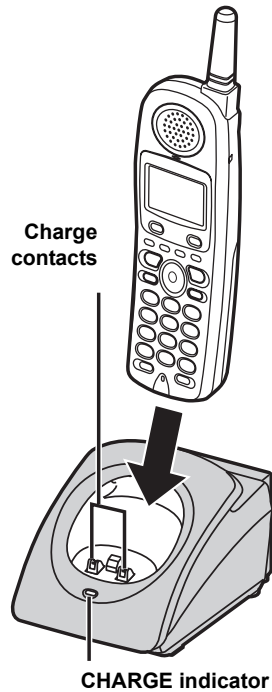



Note:

- To ensure that the battery charges correctly, clean the charge contacts of the cordless handset and charger monthly with a soft, dry cloth. Clean more often if the unit is subject to grease, dust or high humidity.

Battery strength

You can confirm the battery strength on the cordless handset display.

Battery icon	Battery strength
	Fully charged
	Medium
	Low When flashing: needs to be recharged.

Recharging the battery

Recharge the battery when:

- “**Recharge battery**” is displayed and “” flashes on the cordless handset display.
- the cordless handset beeps every 60 seconds while it is in use.

Note:

- Recharge the cordless handset battery for more than 15 minutes or the display will continue showing the indication.

Battery performance

After your Panasonic battery is fully charged, you can expect the following performance:

Operation	Operating time
While in use (talking)	Up to 15 hours ¹
While not in use (standby) ²	Up to 7 days

1. Maximum talk time achieved after several recharge cycles.
2. The cordless handset is off the charger but not in use.

Note:

- Battery power is consumed whenever the cordless handset is off the charger, even when the cordless handset is not in use. The longer you leave the cordless handset off the charger, the shorter you can actually talk on the cordless handset. Actual battery performance depends on a combination of how often the cordless handset is in use and how often it is not in use.
- Once the battery is fully charged, you do not have to charge it again until “**Recharge battery**” is displayed and “” flashes. This will maximize the battery life.
- If you want to keep the battery fully charged at all times, place the cordless handset on the charger when the cordless handset is not in use. The battery cannot be overcharged.

Controls and display

Controls

Base unit

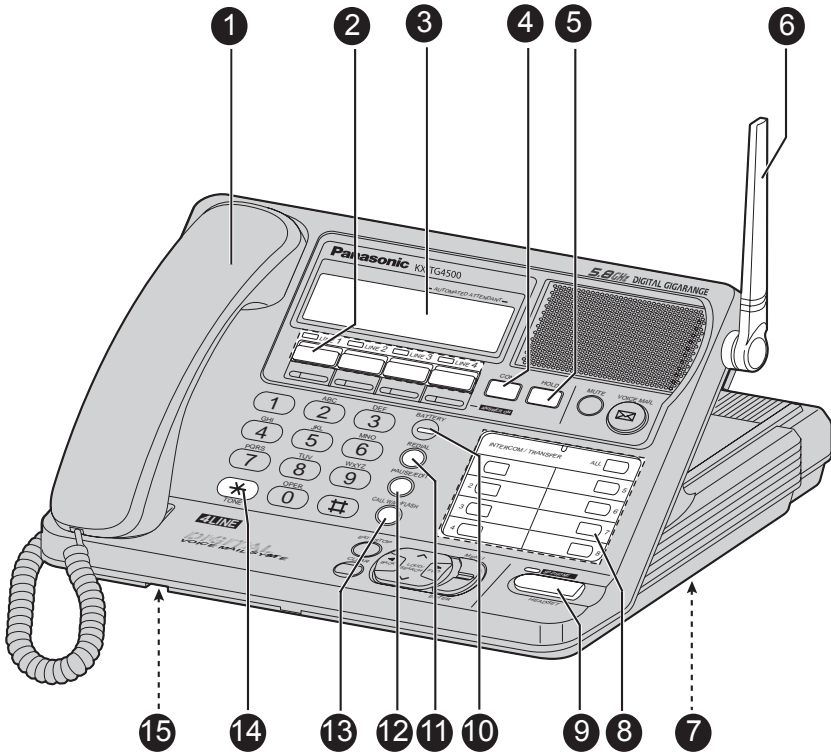

- | | |
|---|------------------------|
| 1 Corded handset | 11 [REDIAL] |
| 2 LINE 1, 2, 3 and 4, and indicators | 12 [PAUSE]/[EDIT] |
| 3 Display | 13 [CALL WAIT]/[FLASH] |
| 4 [CONF] | 14 [TONE] |
| 5 [HOLD] | 15 Microphone |
| 6 Antenna | |
| 7 [RESET] button | |
| 8 [INTERCOM]/[TRANSFER], ([ALL],
[1] to [8]) | |
| 9 [SP-PHONE]/[HEADSET] and
indicator | |
| 10 [BATTERY] indicator | |

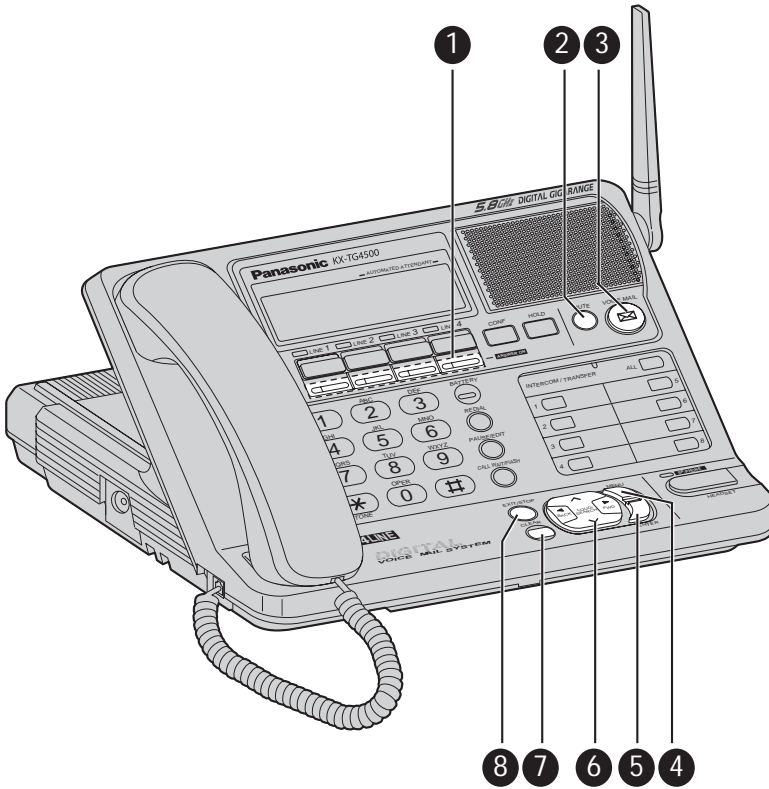

1 [ANSWER ON]

2 [MUTE]

3 ☒ ([VOICE MAIL])

4 [MENU]

5 [ENTER]

6 Navigator key ([V], [^], [◀], [▶])

7 [CLEAR]

8 [EXIT]/[STOP]

Memory card:

Remove the memory card and use it as a name index for the cordless handset(s).

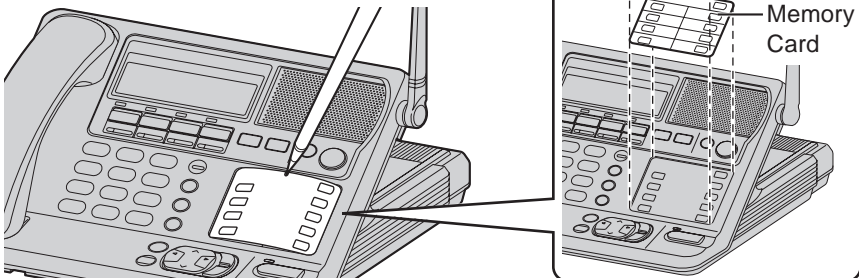

Preparation

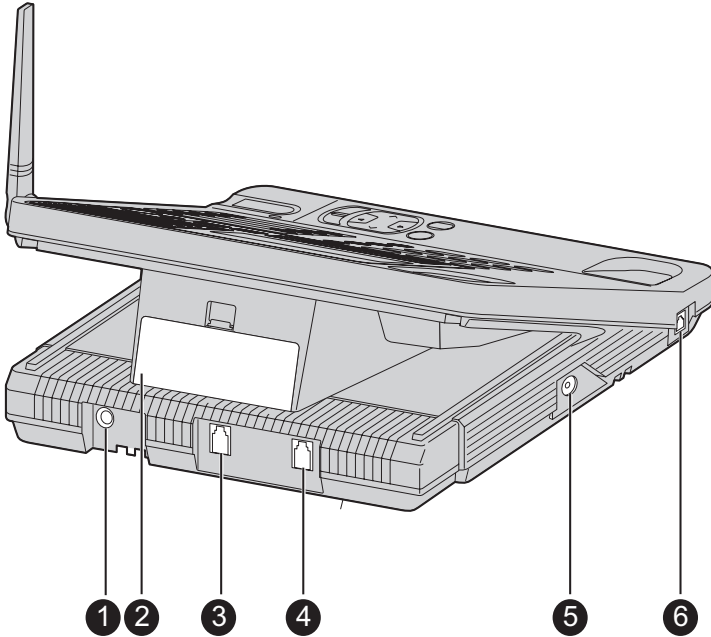

- 1 AC adaptor socket
- 2 Backup battery cover
- 3 Line 3/4 jack
- 4 Line 1/2 jack
- 5 Headset jack
- 6 Base handset socket

Cordless handset

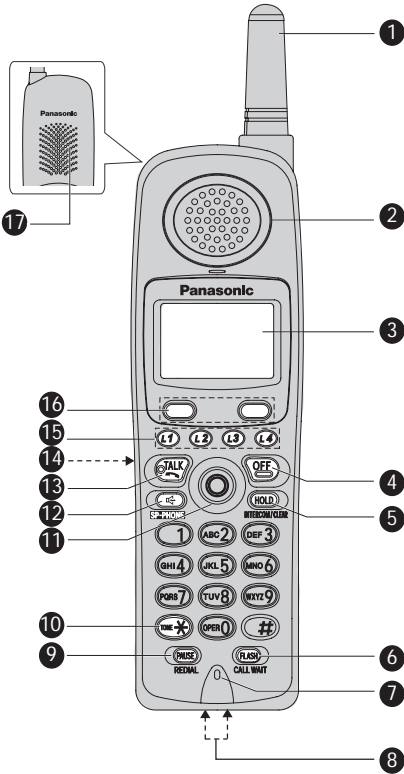

- 1 Ringer indicator
Message indicator
- 2 Receiver
- 3 Display
- 4 [OFF]
- 5 [HOLD]/[INTERCOM]/[CLEAR]
- 6 [FLASH]/[CALL WAIT]
- 7 Microphone
- 8 Charge contacts
- 9 [PAUSE]/[REDIAL]
- 10 [*] (TONE)
- 11 Joystick and [MENU]/[OK]
- 12 [SP-PHONE]
- 13 [TALK]
- 14 Headset jack
- 15 LINE keys
- 16 Softkeys
- 17 Speaker

Charger

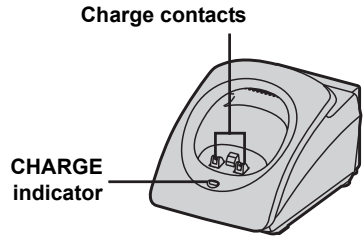

CHARGE indicator:

- The CHARGE indicator lights when the battery is charging.

Note:

- The cordless handset battery requires charging when the battery indicator on the display blinks slowly and the battery low alarm sounds every 60 seconds (page 17).

Using softkeys and navigation keys

Using the cordless handset's softkeys

Two softkeys and the joystick are used to select functions displayed directly above each key. Functions displayed above each key will change depending on the state of use.



Preparation

The cordless handset's softkeys:

Display function	Action
Add	Adds a new record
Back	Moves to the previous step in a menu process
Call	Calls the current contact
Change	Changes the current greeting
Conf	Creates a conference call
Edit	Edits the current record
End	Ends recording
Erase	Erases the current record
M.box	Enters the mailbox
Menu	Displays the main menu
Phb	Enters the Phonebook
Mute	Mutes the conversation during a call
Next	Moves to the next step in a menu process
No	Aborts the current action
OK	Accepts the current option
Option	Displays the available options
Save	Saves the current record
Search	Searches the records
Select	Selects the current option
Start	Starts recording
Yes	Confirms the current action

Using the cordless handset's joystick

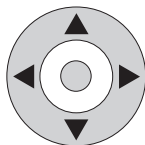

The cordless handset's joystick can be used to navigate through menus and select items shown on the display. Use the

[▲], [▼], [◀], [▶] keys to move the cursor around the screen, then press the **[MENU]/[OK]** key in the center to select an item.

The joystick's up **[▲]** and down **[▼]** keys are also used to scroll through the function menu (page 76), the Caller List (page 48), and the Phonebook (page 43). The up **[▲]** and down **[▼]** keys also increase **[▲]** and decrease **[▼]** the receiver/speaker volumes while in talk mode (page 31).

The **[▶]** key is used to select an item in the displayed menu.

The **[◀]** and **[▶]** keys move the cursor backwards and forwards when inserting a Phonebook item.

The **[◀]** and **[▶]** keys repeat or skip recorded messages.

The **[◀]** key returns you to the previous screen.

Using the base unit's navigator key

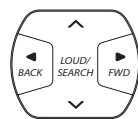

The **[▲]** and **[▼]** keys increase and decrease the base unit speaker volumes and increase or decrease the volume while in talk mode (page 29). The **[▲]** and **[▼]** keys also scroll up and down through the displayed menu, toggle between number entry and name entry when in Phonebook number entry mode (page 43), and opens the Caller List when pressed in standby mode (page 48).

The **[▶]** key selects an item in the displayed menu.

The **[◀]** and **[▶]** keys move the cursor backwards or forwards when inserting a Phonebook item.

The **[◀]** and **[▶]** keys repeat or skip recorded messages.

The **[◀]** key returns you to a previous screen.

Displays

Base

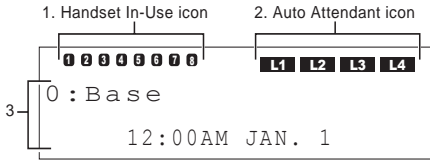

- 1 The handset in-use icon indicates the status of the registered cordless handset(s). If a cordless handset is in talk or intercom mode, or listening to messages, the relevant number is displayed.
- 2 If you turn the automated attendant system on (page 66), the relevant line icon is displayed.
- 3 The time and date are displayed on the last line in standby mode. The display shows the dialed number, call status, programming options, Phonebook items, etc. If you subscribe to a Caller ID service, caller information will be displayed (page 47).

Cordless handset

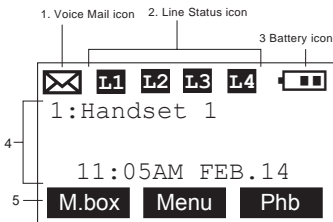

- 1 The  flashes if there is at least one new message in your mailbox (page 55). It is also displayed during message playback.

- 2 The line status icons function as follows:

Line Status	Meaning
Off (invisible)	The line is free.
On	The line is in use.
Flashing	A call is on hold (page 37). The automated attendant or answering system is responding to a call (pages 66 and 71).
Flashing quickly	A call is being received.

- 3 The battery icon indicates the battery strength (page 17).
- 4 The cordless handset number (1 to 8) is displayed in standby mode. The display shows the time and date, dialed number, call status, programming options, and Phonebook items, etc. If you subscribe to a Caller ID service, caller information will also be displayed (page 47).
- 5 The currently available softkeys are displayed; this is dependent on the status of the handset. For a full list of softkeys, refer to page 22.

Backlit LCD displays

Both the base unit and cordless handset have a backlit LCD display.

The lighted cordless handset display will stay on for about ten seconds after pressing a key.

Setting-up the unit before use

Setting the date and time

Base Unit

We recommend that you set the date and time.

Voice Date/Time Stamp: After each message playback, a synthesized voice will announce the date and time that the message was recorded (pages 53 and 55).

Note:

- If a power failure occurs, the date/time will be retained for at least 20 minutes with the backup battery fully charged (page 11). Re-adjust if the date/time is incorrect.
- **For Caller ID service users** (page 47)
 - If the time is set to adjust automatically (page 90), the Caller ID information can set the clock after the first ring if the time is incorrect.
 - If the time is set to adjust automatically, the Caller ID information will automatically adjust the clock for daylight saving time.

1 While in standby mode, press **[MENU]**.

2 Scroll to “**Date and time**” by pressing **[v]** or **[^]**, then press **[ENTER]**.

3 Set the date and time using the keypad keys (**[0]** to **[9]**). Use the **[◀]** or **[▶]** keys to move the cursor to the digit to change, then press the correct number key.

- Enter the time in 12-hour notation. **Do not use military time.**

4 Press **[v]** or **[^]** and hold, to select “**AM**” or “**PM**”.

Example:

Date: 04.28.2006
Time: 02:37 AM
v=PM ENTER=Save

5 Press **[ENTER]**.

- Confirmation tone is heard.

Setting the display language

Base Unit Handset

You can select either “**English**” or “**Español**” as the display language. The default is “**English**”. You must program the base unit and each cordless handset separately.

Note:

- Changing the display language also changes the voice prompts to the selected language.

Specifying the base unit language

1 Press **[MENU]**.

2 Scroll to “**Initial setting**” by pressing **[v]** or **[^]**, then press **[ENTER]**.

3 Scroll to “**Change language**” by pressing **[v]** or **[^]**, then press **[ENTER]**.

4 Press **[v]** or **[^]** to select the desired language.

5 Press **[ENTER]**.

- Confirmation tone is heard.

Specifying cordless handset language

1 Press **[MENU]**.

2 Scroll to “**Initial setting**” by pressing **[v]** or **[^]**, then press **Select**.

3 Scroll to “**Change language**” by pressing **[v]** or **[^]**, then press **Select**.

4 Press **[v]** or **[^]** to select the desired language.

5 Press **Save**.

- Confirmation tone is heard.

Selecting the line mode

Base Unit

The line mode for all lines is preset to “B” and generally should not be changed. If the line indicator on the base unit does not light properly, or the line status icons are not displayed on the cordless handset properly, the line mode selection is incorrect. Set line mode to “A”. Each line has its own setting.

- 1 Press **[MENU]**.
- 2 Scroll to “**Initial setting**” by pressing **[V]** or **[^]**, then press **[ENTER]**.
- 3 Scroll to “**Set telephone line**” by pressing **[V]** or **[^]**, then press **[ENTER]**.
- 4 Scroll to “**Set line mode**” by pressing **[V]** or **[^]**, then press **[ENTER]**.
 - The current settings are displayed.
- 5 Press **[◀]** or **[▶]** to select a line.
- 6 Press **[V]** or **[^]** to select the desired setting.
- 7 Press **[ENTER]**.
 - Confirmation tone is heard.

Selecting the dialing mode

Base Unit

If your lines have a touch-tone service, set to “**Tone**”. If rotary or pulse service is used, set to “**Pulse**”. Select the mode for each line.

The default is “**Tone**”.

- 1 Press **[MENU]**.
- 2 Scroll to “**Initial setting**” by pressing **[V]** or **[^]**, then press **[ENTER]**.

- 3 Scroll to “**Set telephone line**” by pressing **[V]** or **[^]**, then press **[ENTER]**.
- 4 Scroll to “**Set dial mode**” by pressing **[V]** or **[^]**, then press **[ENTER]**.
 - The current settings are displayed.

Example:

Dial mode			
L1	L2	L3	L4
Tone	Tone	Tone	Tone

- 5 Use the **[◀]** or **[▶]** keys to select the line to be set.
- 6 Press **[V]** or **[^]** to select “**Pulse**” or “**Tone**”.
- 7 Press **[ENTER]**.
 - Confirmation tone is heard.

Registering additional cordless handsets

The included cordless handset is pre-registered at the factory and assigned the handset number 1. **Do not try to register handset number 1** which has “1: **Handset 1**” on the display.

Optional cordless handsets must be registered at the base unit. You can add up to seven additional cordless handsets. Only one cordless handset can be registered at a time. The handset number is used as the extension number.

The model number of the optional cordless handset is KX-TGA450. To order, contact your dealer or call 1-800-211-PANA(7262) to locate a dealer.

Note:

- Ensure that the base unit and cordless handset are in standby mode.
- Registration must be completed within one minute.
- The cordless handset cannot be registered if the base unit is not in registration mode.

Preparation

Registering

Handset and Base Unit

You can register handsets in two ways, both are described below. The latter way uses direct commands. For a complete list of direct commands refer to pages 93 through 95.

Method 1:

- 1 From the base unit, press **[MENU]**.
- 2 Scroll to “**Initial setting**” by pressing **[V]** or **[^]**, then press **[ENTER]**.
- 3 Scroll to “**Registration**” by pressing **[V]** or **[^]**, then press **[ENTER]**.
- 4 Scroll to “**HS registration**” by pressing **[V]** or **[^]**, then press **[ENTER]**.
 - The handset registration screen is displayed.

Press MENU, #, 123 on the handset, then press ENTER on base.

- 5 Press **[ENTER]**.
- 6 From the cordless handset, press **OK**.

Registration. 
Press MENU, #,
123 on the base,
then press **OK**

- The cordless handset attempts to register to the base unit.
- After linking to the base unit, the completion screen is displayed and confirmation tone is heard on both the base unit and registered cordless handset.
- Once successfully linked, “**Handset registered**” is displayed on both the base unit and the cordless handset. Repeat to register additional cordless handsets.

- To rename the cordless handset to something memorable, refer to page 83.

Method 2:

- 1 From the base unit, press **[MENU]**, followed by **[#]**, **[1]**, **[2]**, **[3]**.

Press MENU, #, 123 on the handset, then press ENTER on base.

- 2 Press **[ENTER]**.
- 3 From the handset, press **[MENU]**, followed by **[#]**, **[1]**, **[2]**, **[3]**.

Registration. 
Press MENU, #,
123 on the base,
then press **Back** **OK**

- 4 Press **OK**.
 - The cordless handset attempts to register to the base unit.
 - After linking to the base unit, the completion screen is displayed and confirmation tone is heard on both the base unit and registered cordless handset.
 - Once successfully linked, “**Handset registered**” is displayed on both the base unit and the cordless handset. Repeat to register additional cordless handsets.
 - To rename the cordless handset to something memorable, refer to page 83.

De-registering a cordless handset

Base Unit

Note:

- De-registering a cordless handset clears all data on the base unit for the selected cordless handset.

- 1** While the base unit is in standby mode, press **[MENU]**.
- 2** Scroll to “**Initial setting**” by pressing **[V]** or **[^]**, then press **[ENTER]**.
- 3** Scroll to “**Registration**” by pressing **[V]** or **[^]**, then press **[ENTER]**.
- 4** Scroll to “**Deregistration**” by pressing **[V]** or **[^]**, then press **[ENTER]**.

Example:

```
Deregistering
HS No.: 1234----
<>          ENTER=Select
```

- The numbers of the currently registered cordless handsets are displayed.
 - If there are no cordless handsets registered, an error beep is heard and an error message displayed (page 101).
- 5** Press **[◀]** or **[▶]** to move to the cordless handset to be de-registered.
 - 6** Press **[ENTER]**.
 - 7** Press **[ENTER]** again to confirm the operation.
 - The completion screen is displayed and confirmation tone is heard.

Making calls

Four external calls can be handled simultaneously on separate telephone lines by the base unit and three cordless handsets (or by four cordless handsets). Additionally, two intercom calls can be handled simultaneously. The maximum operating number may decrease depending on the state of use.

Using the base unit **Base Unit**

When you lift the base unit handset or press **[SP-PHONE]** to make a call, the unit automatically selects an available line (to change the line selection, see page 84) and you can dial a phone number. To hang up, replace the handset or press **[SP-PHONE]**.

Note:

- You can also pre-dial the phone number before lifting the base unit handset (page 29).
- If the base unit and three cordless handsets or four other cordless handsets are in use, you may not be able to make a call. In this case “The system is busy. Please try again later.” is displayed.
- If the unit detects a problem, an error message is displayed (page 101).

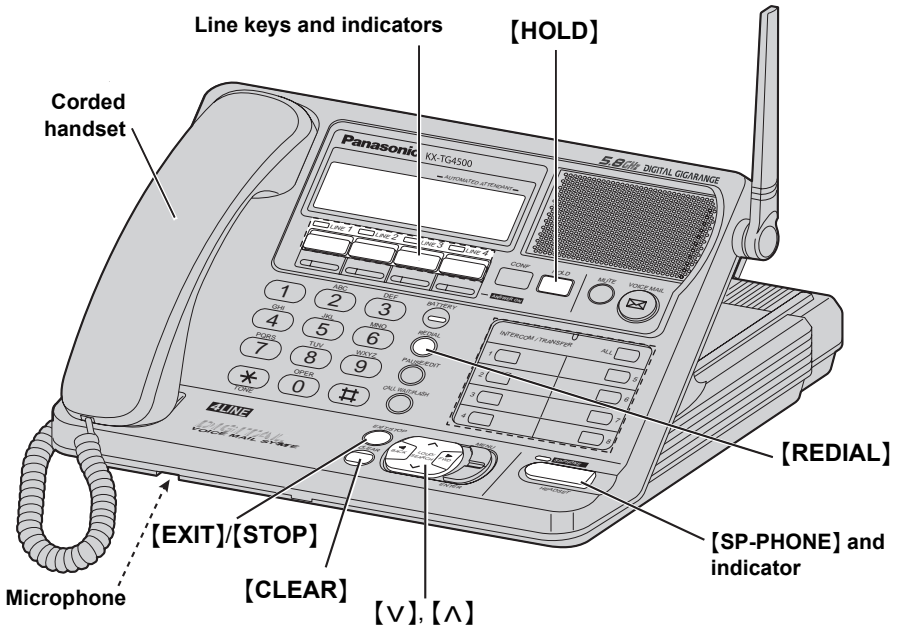

Holding a handsfree conversation

- 1 Press **[SP-PHONE]**.
 - The SP-PHONE indicator lights.
 - An available line is automatically selected and the line indicator lights (to change the line selection, see page 84).
 - You can select a line by pressing an unlit **LINE** key, instead of pressing **[SP-PHONE]**.
- 2 Dial the phone number.
 - If you misdial, press **[SP-PHONE]**, and start again from step 1.
- 3 When the other party answers, talk into the microphone.
- 4 When you finish talking, press **[SP-PHONE]** or place the handset on the base unit (if the call was switched to the handset).
 - The SP-PHONE indicator light goes out.

For best performance:

- Talk alternately with the caller in a quiet room.
- If the other party has difficulty hearing you, press **[V]** to decrease the speaker volume.
- You can switch to the handset by lifting it up. To switch back to the speakerphone, press **[SP-PHONE]**.
- Press **[SP-PHONE]** again to switch back to the handset.

Dialing after confirming the entered number

- 1 Enter the phone number.
 - To correct a digit, press **[CLEAR]**. Enter the correct number.
 - If a pause is required when dialing, press **[PAUSE]** where needed (page 41).
 - To delete all digits, press and hold **[CLEAR]**.

- 2 Press **[SP-PHONE]**.
 - You can press a line key instead of pressing **[SP-PHONE]**.
 - The line number is displayed.
- 3 When the other party answers, talk into the handset or microphone.
- 4 When you have finished speaking, replace the handset or press **[SP-PHONE]**.

Adjusting the base unit handset volume

Three levels (high/medium/low) are available for the handset volume.

Press **[V]** or **[^]** repeatedly during a call to increase or decrease the volume.

- Each time you press **[V]** or **[^]**, the volume level will change.

Adjusting the speakerphone volume

Eight volume levels (high to low) are available for the speaker volume.

Press **[V]** or **[^]** repeatedly during a call to increase or decrease the volume.

- Each time you press **[V]** or **[^]**, the volume level will change.

Adjusting the volume if you have an optional headset

Refer to "To connect an optional headset to the base unit" on page 98 for details on attaching a headset.

Three volume levels are available.

Press **[V]** or **[^]** repeatedly during a call to increase or decrease the volume.

- Each time you press **[V]** or **[^]** the volume level will change.

Redialing the last number dialed

- 1 Lift the base unit handset or press **[SP-PHONE]**.
 - You can press a line key instead of **[SP-PHONE]**.
- 2 Press **[REDIAL]**.
 - The last dialed phone number from the base unit is redialed.

Making/Answering Calls

Making a call using the redial list

The last 10 different phone numbers dialed from the base unit are stored in the redial list.

- 1 Press **[REDIAL]**.
 - The last number dialed is displayed.
 - If **"No items stored"** is displayed, the list is empty.
- 2 Press **[v]** or **[^]** repeatedly to scroll through the list, or press **[REDIAL]** repeatedly to display the desired number.
 - To exit the list, press **[EXIT]**.
- 3 Lift the base unit handset or press **[SP-PHONE]**.
 - You can press a line key instead of **[SP-PHONE]**.

Dialing speed dial numbers

Refer to "Storing speed dial numbers" on page 91 for details of how to set-up speed dial keys.

- 1 While in standby mode, press and hold a dial key (**[0]** to **[9]**) for more than three seconds.
 - The assigned speed dial for the key is displayed.
 - If a speed dial number has not been assigned to this key, **"No number"** is displayed.
- 2 Lift the base unit handset or press **[SP-PHONE]**.
 - You can press a line key instead of **[SP-PHONE]**.
 - The speed dial number is called.

Note:

- The speed dial function can be used with the base unit handset or in handsfree mode (page 29).

Using the cordless handset

Handset

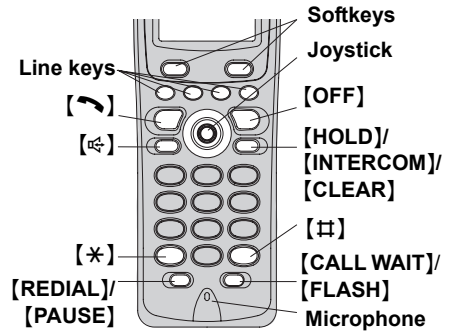

- 1 Press **[↶]** or **[↷]**.
 - An available line is automatically selected and the line is displayed (to change the line selection, see page 84).
 - You can select a line by pressing **[L1]**, **[L2]**, **[L3]**, or **[L4]**, instead of pressing **[↶]** or **[↷]**.
 - **"Talk"** or **"SP-phone"** is displayed.
- 2 Dial the phone number.
 - The dialed number is displayed.

Example:



- After a few seconds the display will show the length of the call.

Example:



- 3 When finished talking, press **[OFF]** or place the cordless handset on the charger.

Note:

- If the base unit and three cordless handsets or four cordless handsets are in use, you may not be able to make a call. In this case **"The system is busy. Please try again later."** is displayed.

Holding a handsfree conversation

- 1 Press **[☎]**.
 - An available line is automatically selected and the line is displayed (to change the line selection, see page 84).
 - “**SP-phone**” is displayed.
- 2 Dial the phone number.
 - The dialed number is displayed.
 - After a few seconds the display will show the length of the call.
- 3 When the other party answers, talk into the microphone.
- 4 When finished talking, press **[OFF]** or place the cordless handset on the charger.

For best performance:

- Talk alternately with the caller in a quiet room.
- If the other party has difficulty hearing you, press **[▼]** to decrease the speaker volume.
- During a call you can switch from the receiver to the speakerphone by pressing **[☎]**. To switch back to the receiver, press **[📞]**.

Dialing after confirming the entered number

- 1 Enter the phone number.
 - To correct a digit, press **[CLEAR]**. Enter the correct number.
 - If a pause is required when dialing, press **[PAUSE]** where needed (page 41).
 - To cancel, press **[CLEAR]** and hold, or press **[OFF]**.
- 2 Press **[📞]** or **[☎]**.
 - You can press a line key instead of pressing **[📞]** or **[☎]**.
 - The line number is displayed.

- After a few seconds, the display will show the length of the call.

Example:



- 3 When finished talking, press **[OFF]** or place the cordless handset on the charger.

Adjusting the cordless handset volume

Three levels (high/medium/low) are available.

While using the receiver, press **[▼]** or **[▲]** repeatedly.

Example:

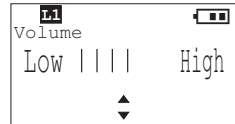

Adjusting the speaker volume

Six levels (high to low) are available.

While using the speaker, press **[▼]** or **[▲]** repeatedly.

Example:

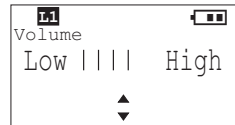

Lighted cordless handset keypad

The cordless handset dialing keys light when a call is received or a key is pressed. The lights go out about 10 seconds after pressing a key, lifting the cordless handset off the charger or answering a call.

Adjusting the volume if you have an optional headset

Refer to “To connect an optional headset to the cordless handset” on page 99 for details on attaching a headset.

Three volume levels are available.

Making/Answering Calls

Press [**▼**] or [**▲**] repeatedly during a call to increase or decrease the volume.

Each time you press [**▼**] or [**▲**] the volume level will change.

Redialing the last number dialed

Press [**↶**] or [**↷**], then press [**REDIAL**].

Making a call using the redial list

The last ten different phone numbers dialed from the cordless handset are stored in the redial list.

1 Press [**REDIAL**].

- The last number dialed is displayed.
- If “**No items stored**” is displayed, the list is empty.

2 Press [**▼**] or [**▲**] repeatedly to scroll through the list, or press [**REDIAL**] repeatedly until the desired number is displayed.

- To exit the list, press [**OFF**].

3 Press [**↶**] or [**↷**].

Dialing speed dial numbers

Refer to “Storing speed dial numbers” on page 91 for details of how to set-up speed dial keys.

1 While in standby mode, press and hold a dial key ([**0**] to [**9**]) for more than three seconds.

- The assigned speed dial for the key is displayed.
- If a speed dial number has not been assigned to this key, “**No Number**” is displayed.

2 Press [**↶**] or [**↷**].

- You can press a line key instead of pressing [**↶**] or [**↷**].
- The speed dial number is called.

Note:

- This function can be used with the handset or in handsfree mode (page 31).

Answering calls

Four external calls can be handled simultaneously (or two intercom calls) by the base unit and three cordless handsets (or by four cordless handsets). When a call is received, the unit rings and “**Incoming call**” is displayed. The called line indicator on the base unit flashes quickly, and the line status icon flashes quickly on the cordless handset display.

The line is automatically selected when the call is answered.

If you subscribe to a Caller ID service, the calling party’s information will be displayed after the first ring (page 47).

To view the Caller ID information, wait until the second ring to answer a call.

When an intercom call (page 35) and an external call are received at the same time, the information for each call will be displayed alternately. Press [**SP-PHONE**] or go off-hook (using the base unit) or press [**↶**] or [**↷**] (using the cordless handset) to answer the intercom call.

Press the line key to answer the external call.

Note:

- When the base unit and cordless handset ringer volumes are set to OFF, they will not ring. “**Ringer off**” is also displayed while the base unit/cordless handset(s) is in standby mode (page 80).

Using the base unit **Base Unit**

You can answer a call by simply lifting the base unit handset. If the caller's information is stored in the Phonebook (page 43) or in the Caller list (page 48), the caller's name and number are displayed, otherwise "Incoming call" is displayed. To hang up, replace the handset.

Example:

```
John Smith
1-012-345-6789
-----Line 1-----
```

If two calls are received together, the one with the lowest line number has priority when the base unit handset is picked up. You can also answer a call by pressing **[SP-PHONE]** (see below) or pressing a **LINE** key to answer a call on a specific line. If you receive an incoming call while using the mailbox (page 51), the display shows "Incoming call" and the incoming call tone will be heard. If the caller's information is stored in the Phonebook (page 43) or in the Caller list (page 48), the caller's name and number are also displayed.

Answering using the speakerphone

1 Press **[SP-PHONE]**.

- The indicator lights.
- The called line indicator light stops flashing.
- You can also answer a call by pressing the called line key (**[Line1]**, **[Line2]**, **[Line3]** or **[Line4]**).

2 Talk into the microphone.

3 When finished talking, press **[SP-PHONE]**.

Note:

- To transfer a call to another extension user, see page 36. To transfer the call to a mailbox to enable a caller to leave a message, see page 58.

Temporarily turning the ringer off

While the base unit is ringing for an outside call, you can turn the ringer off temporarily by pressing **[MUTE]**. The base unit will ring the next time a call is received.

To turn the ringer off permanently, see page 80.

Using the cordless handset

Handset

1 Press **[]** or **[]**.

- The called line status icon stops flashing.
- You can also answer a call by pressing the called line key (**L1**, **L2**, **L3** or **L4**).

OR:

If the cordless handset is on the charger, just lift it off. (This is not possible when the Auto Talk feature is set to OFF. See below and page 81).

2 When finished talking, press **[OFF]** or place the cordless handset on the charger.

Note:

- If you are using the mailbox (page 51) and receive an incoming call, the display shows "Incoming call" or the Caller ID information (page 47), if enabled, and incoming call tone is heard.

Example:

```
L1 
JOHN SMITH
1-012-345-6789
----- Line 1 -----
Mute
```

Auto talk

This feature allows you to answer a call by simply lifting the cordless handset off the charger. You do not need to press **[]**.

To activate this feature, see page 81.

Making/Answering Calls

Temporarily turning the ringer off

While the cordless handset is ringing for an outside call, you can turn the ringer off temporarily by pressing **Mute**. The cordless handset will ring the next time a call is received.

To turn the ringer off permanently, see page 80.

Using additional lines during a conversation

During a conversation, if an incoming call is received on another line, the line indicator on the base unit and the line status icon on the cordless handset display will flash quickly. You will also hear two tones through the cordless handset or base unit handset.

You can make or answer a second call while the first call is on hold.

- If you subscribe to a Caller ID service, the second caller's information will be displayed when a call is being received on another line (page 47).

Using the base unit **Base Unit**

Example: If you are using LINE 1

- 1 Press **[HOLD]** to put the first call (LINE 1) on hold (page 37).
 - The LINE 1 indicator flashes.
- 2 Press another line key (LINE 2, 3 or 4) to make or answer a second call.
 - The selected LINE indicator lights.
- 3 To return to the first call (LINE 1), press the line key for the first call (LINE 1).
 - The second call is terminated.

Example:



Note:

- To place the second call on hold, press **[HOLD]** in step 3 before pressing the line key for the first call.
- Pressing **[HOLD]** puts the current call on hold. You can make or answer another call by pressing the line key for a line not in use. You can handle up to four calls at a time.

Using the cordless handset

Handset

Example: If you are using LINE 1

- 1 Press **[HOLD]** twice to put the first call (LINE 1) on hold (page 37).
 - The line status icon flashes.
- 2 Press another line key (LINE 2, 3 or 4) to make or answer a second call.
- 3 To return to the first call (LINE 1), press the line key for the first call (LINE 1).
 - The second call is terminated.

Example:



Note:

- To hold the second call, press **[HOLD]** twice, then press the line key for the first call.
- Pressing **[HOLD]** twice puts the current call on hold while keeping the previously held calls active. You can make or answer another call by pressing the line key for a line not in use. You can handle up to four calls at a time.

Intercom

Intercom calls can be made between a cordless handset and the base unit or between two cordless handsets. You can page all cordless handsets simultaneously from the base unit.

The number assigned to a cordless handset at registration is the extension number (page 25). The base unit extension number is 0.

Note:

- If you have difficulty hearing while using the speakerphone on the base unit or the cordless handset, decrease the speaker volume by pressing [V].
- If an incoming call is received during an intercom call, you will hear incoming call tone and the line indicator will flash quickly.
- When an intercom call and an external call (page 32) are received at the same time, the information for each call will be displayed alternately. Lift the handset or press [SP-PHONE] (base unit) or press [📞] or [📞] (cordless handset) to answer the intercom call. Press the line key to answer the external call.

Making an intercom call

Base Unit **Handset**

Using the base unit

- 1 While the base unit is in standby mode, press a key from [INTERCOM 1] to [INTERCOM 8] or press [INTERCOM ALL].
- 2 When the other party's voice is heard, lift the base unit handset or talk into the microphone.
- 3 To end the call, replace the handset or press [SP-PHONE].

Note:

- Using this feature can help you locate a misplaced cordless handset.

Using the cordless handset

- 1 While the cordless handset is in standby mode, press [INTERCOM].
- 2 Press [▼] or [▲] to scroll to the base unit or required cordless handset.
 - Press [✖] to select the base unit and all cordless handsets.
 - Only registered cordless handsets are displayed.
- 3 Press **Select** or [OK].
- 4 To end the call, press [OFF].

Answering intercom calls

Base Unit **Handset**

Using the base unit

While the base unit is ringing, lift the handset or press [SP-PHONE].

To end the call, replace the handset or press [SP-PHONE].

Using the cordless handset

While the cordless handset is ringing, press [📞], [📞], or [INTERCOM], or lift the handset off the charger if auto talk is enabled (page 81).

To end the call, press [OFF], or place the handset on the charger.

Note:

- When the base unit and cordless handset ringer volumes are set to OFF, they will not ring. "Ringer off" is also displayed while the base unit/cordless handset(s) is in standby mode (page 80).
- If an incoming call is being received, the line indicator on the base unit will flash quickly or the cordless handset user will hear incoming call tone. To answer, press the relevant line key.

Transferring a call

You can transfer an external call between the base unit and a cordless handset, or between two cordless handsets.

Note:

- If the paged party does not answer within 30 seconds after you hang up, the transferred call will be returned to you with an audible tone. If the call is still not answered after 10 minutes, the automated attendant will respond to the caller (page 66). You may answer the call by pressing the relevant line key before the tone or before the automated attendant takes the call.
- Any user can accept a transferred call by pressing the relevant line key.
- For information on transferring a call to a mailbox, refer to “Transferring a call to a personal mailbox” on page 58.

Using the base unit **Base Unit**

- 1** During a call, press the corresponding **TRANSFER** key ([**1**] to [**8**]) to page the cordless handset.
To page all cordless handsets, press **TRANSFER [ALL]**.
 - The call is put on hold and the line indicator flashes.
 - If you press **TRANSFER [ALL]**, only the cordless handset user who answers first can take the transferred call.
- 2** If required, wait for the cordless handset user to answer and announce the transfer. If not required, go to step 3.
 - If the paged party does not answer, press the relevant line key.
- 3** To complete the transfer, replace the handset or press [**SP-PHONE**].

Answering a call transferred to the base unit

When the base unit rings, lift the handset or press [**SP-PHONE**].

- After the paging party hangs up, you can talk to the outside caller.
- You can press the relevant line key instead of pressing [**SP-PHONE**] to talk to the outside caller.

Using the cordless handset

Handset

- 1** During a call, press [**INTERCOM**]/[**HOLD**]/[**TRANSFER**].
- 2** Press [**▼**] or [**▲**] to scroll to the required cordless handset or base unit.
Press [**✳**] to select the base unit and all cordless handsets.
- 3** Press **Select** or [**OK**].
- 4** If required, wait for the paged party to answer, announce the transfer.
If not required, go to step 5.
 - If the paged party does not answer, press the relevant line key.
- 5** To complete the transfer, press [**OFF**] or place the handset on the charger.

Answering a call transferred to a cordless handset

When the handset rings, press [**↶**] or [**↷**], or lift the handset off the charger.

- After the paging party hangs up, you can talk to the outside caller.
- You can press the relevant line key instead of pressing [**↶**] or [**↷**] to talk to the outside caller.

Placing a call on hold

This feature allows you to put an outside call on hold.

Using the base unit **Base Unit**

During an outside call, press **[HOLD]**.

- “Hold” and the line number are displayed.

Example:



Note:

- If a call is kept on hold for more than six minutes, a warning tone is heard. After four additional minutes on hold, the automated attendant will respond to the caller who can then call a cordless handset or leave a message following the Incomplete Call Handling Menu (page 69).
- Replacing the handset on the cradle will not affect the held call.

To return to the call, press the line key of the held call.

Note:

- Cordless handset users can release the held caller by pressing the relevant line key.

Using the cordless handset

Handset

During an outside call, press **[HOLD]** twice.

- “Hold” and the line number are displayed.

Example:

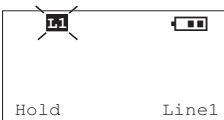

- The line status icon flashes on the display.

- If a call is kept on hold for more than six minutes, a warning tone is heard. After four additional minutes on hold, the automated attendant will respond to the caller and he/she can call the base unit, another cordless handset or leave a message following the Incomplete Call Handling Menu (page 69).

- Replacing the cordless handset in the charger will not affect the held call.

To return to the call, press the line key of the held call.

Note:

- The base unit and other cordless handset users can release the held caller by pressing the relevant line key.

Swapping between two external calls

To swap between two external calls, both calls must first be put on hold (page 37). To connect to one of the held calls, press the line key for that call. To connect to the second call, place the current call on hold and press the line key for the second call.

Conference calls

This feature allows you to join two calls to make a conference call. At least one of the other two parties must be an external line.

Conference with two external calls using the base unit

Base Unit

Example: If you are using LINES 1 and 2

- 1 During an outside call, press **[HOLD]** to put the call (LINE 1) on hold (page 37).
- 2 Press **[Line2]** to make or answer a second call.
- 3 When the second call is connected, press **[CONF]** to make a conference call.
 - All calls are connected.

Example:

```
Conference
          00-00-20
L1 L2
```

- **To hang up both lines**, press **[SP-PHONE]**.
- **To hang up only one line**, press the line key for the party with which you want to continue talking.
- **To put both lines on hold**, press **[HOLD]**. You can speak to one of the held calls by pressing the line key for that call. To let the other party join the conversation again, press **[CONF]**.

Note:

- During a conference with two external calls, both calls will be dropped if a line key not associated with either call is pressed.

Conference with two external calls using the cordless handset **Handset**

Example: If you are using LINES 1 and 2

- 1 During an outside call, press **[HOLD]** twice to put the first call (LINE 1) on hold (page 37).
- 2 Press **[L2]** to make or answer a second call.
- 3 When the second call is connected, press **Conf** to make a conference call.
 - All calls are connected.

Example:

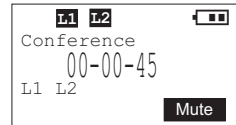

- **To hang up both lines**, press **[OFF]** or place the cordless handset on the charger.
- **To hang up only one line**, press the line key for the party with which you want to continue talking.
- **To put both lines on hold**, press **[HOLD]**. To talk with only one caller, press the corresponding line key. To let the other party join the conversation again, press **Conf**.

Conference with an external call and cordless handset (using the base unit) **Base Unit**

Example: If you are using LINE 1

- 1 During an outside call, press **[HOLD]** to put the first call (LINE 1) on hold (page 37).
- 2 Press the corresponding **[INTERCOM]** key (**[1]** to **[8]**) to page the required cordless handset or press **[INTERCOM ALL]**.

- 3 When the second call is connected, press **[CONF]** to make a conference call.
 - All calls are connected.
 - **To leave the conference**, replace the base unit handset or press **[SP-PHONE]**. The two other parties can continue the conversation.

Conference with an external call and base unit or another cordless handset (using a cordless handset) **Handset**

Example: If you are using LINE 1

- 1 During an outside call, press **[INTERCOM]**.
- 2 Press **[▼]** or **[▲]** to scroll to the required cordless handset or base unit, then press **Select**.
 - You can also select a handset with a number key (**[0]** to **[8]**) or press **[*]** to page the base unit and all cordless handsets.
- 3 When the second call is connected, press **Conf** to make a conference call.
 - All three calls are connected.
 - **To leave the conference**, press **[OFF]** or place the cordless handset on the charger. The two other parties can continue the conversation.

Useful features during a call

Joining in a conversation

Base Unit **Handset**

This feature allows the base unit user or another cordless handset user to join in a current conversation.

Note:

- The base unit user or a cordless handset user cannot join a conversation between a cordless handset or the base unit and an external caller if Call Privacy has been turned on (page 39) by the base unit or another cordless handset user.

Example: A conversation is currently taking place between Handset 1 and a call on LINE 3.

Press and hold **[Line3]** on the base unit or another cordless handset.

- You join in the current conversation, “**Conference**” is displayed.

Example (from the base unit):

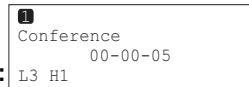

Call privacy **Base Unit** **Handset**

Call privacy allows you to prevent other users from joining in your conversation with an outside caller.

Note:

- This feature is activated on a per-call basis.
- You cannot activate this feature during an intercom call or a conference call.

Using the base unit

- 1 While in conversation with an external caller, press **[MENU]**.
- 2 Press **[▼]** or **[▲]** to scroll to “**Privacy ON**”.

Making/Answering Calls

3 Press **[ENTER]**.

- A cordless handset user cannot join-in your current conversation.

Example:

```
Talk                Line1
                   00-01-32
<Privacy>
```

Using the cordless handset

1 While in conversation with an external caller, press **Menu**.

2 Press **[v]** or **[^]** to scroll to “**Privacy ON**”, followed by **Select**.

- Other cordless handset or base unit users cannot join-in your current conversation.

Recording a conversation

Base Unit **Handset**

This feature allows you to record your conversation with an external caller.

Note:

- Many states have imposed regulations on the manner in which 2-way conversations may be recorded; you should inform the other party that the conversation is being recorded. Consult your telephone service provider for further information.
- You cannot record internal or conference calls.

1 While in conversation with an external caller, press **[MENU]**.

2 Press **[v]** or **[^]** to scroll to “**2-way record ON**”.

3 If using the base unit, press **[ENTER]**. If using the handset, press **Select**.

- Recording starts.

Example (from the base unit):

```
Talk                Line1
                   00-01-32 Rec
<Privacy>
```

- To stop recording:

If using the base unit, press **[MENU]**, followed by **[ENTER]**.

If using the handset, press **[MENU]**, followed by **Select**.

Note:

- If the memory becomes full during the conversation, recording stops and you will hear an error beep.
- When recording is selected, the Call Privacy feature (page 39) activates.

Muting your conversation

Base Unit **Handset**

You can mute your voice during a conversation. While mute is turned on you will be able to hear the other party, but the other party will not be able to hear you.

Using the base unit

During a conversation, press **[Mute]**.

- “<Mute>” will flash on the display.
- To return to the conversation, press **[Mute]** again.

Using the cordless handset

During a conversation, press **Mute**.

- **Mute** will flash slowly on the display.
- To return to the conversation, press **Mute** again.

Using the PAUSE key (for PBX line or long distance calls)

Base Unit Handset

A pause is sometimes required when making calls using a PBX or long distance service.

For example, if you need to dial the line access number "9" when making outside calls with a PBX:

- 1 Press **[9]**.
- 2 Press **[PAUSE]**, then dial the phone number.

Example (from the base unit):

Talk	Line1
9P012	

Note:

- A 3.5 second pause is inserted each time **[PAUSE]** is pressed. Press **[PAUSE]** repeatedly to insert longer pauses.

Using the FLASH key Base Unit Handset

Pressing **[FLASH]** allows you to use special features of your host PBX, such as, transferring an extension call, or accessing optional telephone services such as Call Waiting (page 41).

- Pressing **[FLASH]** cancels mute (page 40) and temporary tone dialing mode (page 42).

Note:

- To change the flash time, see page 84.

For call waiting service users

Base Unit Handset

If a call is received on the same line as the current conversation, you will hear call waiting tone. Press **[CALL WAIT]** to answer the second call.

To use Call Waiting, you must subscribe to your telephone service provider's Call Waiting service.

- The first call is put on hold while you answer the second call.
- To switch between calls, press **[CALL WAIT]**.
- The call waiting service cannot be used when:
 - the first call on the same line is on hold, or
 - the automated attendant system or Answering System is responding to the first call on the same line (pages 66, 71).

Note:

- Please contact your telephone service provider for details and availability of this service in your area.

Call waiting caller ID display

If you subscribe to both Caller ID and Call Waiting with Caller ID services (CWID), when a second call is received on the same line while talking, the second caller's information will be displayed. After you hear call waiting tone while talking, the display shows the caller's name with the phone number, and "Waiting" is displayed.

Example (from the base unit):

John Smith
0-123-456-7890
-----Waiting-----

Temporary tone dialing

Base Unit Handset

You can temporarily switch the dialing mode from pulse to tone when you need to access touch tone services (for example, answering services, telephone banking services, etc.).

During a call, press **【*】** (to enter tone dialing mode) before entering access numbers which require tone dialing.

Note:

- The dialing mode will return to pulse when you hang up.

Using the Phonebook

You can store names and phone numbers in the base unit and cordless handset's Phonebooks. 100 items can be stored in each Phonebook. All Phonebook items are sorted in alphabetical order. Using the Phonebook, you can make a call by selecting a name from the list.

Note:

The base unit and every cordless handset have separate Phonebooks. You must set up each Phonebook individually.

Storing names and numbers in the Phonebook **Base Unit**

Handset

Note:

- The storage of items must be carried out separately for the base unit and cordless handset(s).
- Ensure that the base unit/cordless handset is in standby mode.

Using the base unit

- 1 Press **[MENU]**.
- 2 Scroll to "Add phonebook" by pressing **[v]** or **[^]**, then press **[ENTER]**.
 - The display shows the number of items in the Phonebook.
- 3 Enter the name (max. 16 characters). See the character table for entry (page 44).

Example:



- 4 Press **[ENTER]**.
- 5 Enter the phone number (max. 32 digits).

- If a pause is required, press **[PAUSE]** where needed (page 41).

Example:



- 6 Press **[ENTER]**.
 - Confirmation tone is heard.
 - To continue adding items, repeat from step 2.

Note:

- If the display shows "Memory is full" in step 2, erase unnecessary Phonebook items (page 46).

Using the cordless handset

- 1 Press **[MENU]**.
- 2 Scroll to "Add phonebook" by pressing **[v]** or **[^]**, then press **Select**.
 - The display shows the number of items in the Phonebook.
- 3 Enter the name (max. 16 characters). See the character table for entry (page 44).

Example:



- 4 Press **Next**.
- 5 Enter the phone number (max. 32 digits).
 - If a pause is required when dialing, press **[PAUSE]** where needed (page 41).

Example:

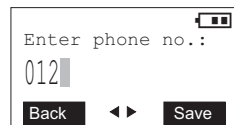

- 6 Press **Save**.
 - Confirmation tone is heard.
 - To add other items, repeat from step 2.

Phonebook

Note:

- If the display shows “Memory is full” in step 2, erase unnecessary Phonebook items (page 46).

Character table

The number keys are used to enter characters. To enter a character, press the appropriate dial key repeatedly, as necessary. To enter another character that is located on the same dial key, press [▶] to move the cursor to the next space, or wait for the cursor to advance automatically to the next character.

Key	Characters
[1]	& ' () , - . / 1
[2]	a b c A B C 2
[3]	d e f D E F 3
[4]	g h i G H I 4
[5]	j k l J K L 5
[6]	m n o M N O 6
[7]	p q r s P Q R S 7
[8]	t u v T U V 8
[9]	w x y z W X Y Z 9
[0]	Space 0
[*]	*
[#]	#
[◀]	Moves the cursor to the left.
[▶]	Moves the cursor to the right. (To enter another character using the same key, move the cursor to the next space.)
[CLEAR]	Deletes the character or digit to the left of the cursor.

If you make a mistake while entering a name:

Press [◀] or [▶] to move the cursor to the incorrect character, press [CLEAR] to delete, and enter the correct character. Each time you press [CLEAR] a character is erased to the left of the cursor. To erase all characters, press and hold [CLEAR].

For example, to enter “Tom Jones”:

- 1 Press [8] four times.
- 2 Press [6] three times and wait for the cursor to move to the next character.
- 3 Press [6] once.
- 4 Press [0] once.
- 5 Press [5] four times.
- 6 Press [6] three times and wait for the cursor to move to the next character.
- 7 Press [6] twice.
- 8 Press [3] twice.
- 9 Press [7] four times.

Finding and calling a Phonebook item

Base Unit Handset

Phonebook items can be searched for alphabetically or by scrolling through the Phonebook.

Note:

- You can leave the Phonebook at any time by pressing [EXIT] on the base unit or [OFF] on the cordless handset.
- If “No items stored” is displayed, the Phonebook is empty.

Scrolling through the Phonebook from the base unit

- 1 Press [◀] or [▶] to enter the Phonebook.
 - The number of items held are displayed.
- 2 Press [v] or [^] repeatedly to display the desired item.
- 3 Lift the handset or press [SP-PHONE].
 - The number is dialed automatically.
 - You can press a line key instead of pressing [SP-PHONE].

Searching for a name by initial from the base unit

- 1 Press [**◀**] or [**▶**] to enter the Phonebook.
 - The number of items held are displayed.
- 2 Press [**√**] to display the first Phonebook item.
- 3 Press the dialing key (**[0]** to **[9]**) which corresponds to the first letter you are searching for (see the character table, page 44).

Example: To find “SARAH”, press [**7**] repeatedly until the first item under “s” is displayed.
- 4 Press [**√**] until the name is displayed.
- 5 Lift the base unit handset or press [**SP-PHONE**] or an available line key.
 - The number is dialed automatically.

Scrolling through the Phonebook from the cordless handset

- 1 While the cordless handset is in standby mode, press **Phb** to enter the Phonebook.
 - The number of items held is displayed.
- 2 Press [**▼**] or [**▲**] repeatedly to display the desired item.
- 3 Press [**↶**] or [**↷**].
 - The number is dialed automatically.
 - You can press a line key instead of pressing [**↶**] or [**↷**].

Searching for a name by initial from a cordless handset

- 1 While the cordless handset is in standby mode, press **Phb** to enter the Phonebook.
 - The number of items held is displayed.
- 2 Press **Search**.

- 3 Press the dialing key (**[0]** to **[9]**) which corresponds to the first letter you are searching for (see the character table, page 44).

Example: To find “SARAH”, press [**7**] repeatedly until the first item under “s” is displayed.
- 4 Press [**▼**] until the name is displayed.
- 5 Press [**↶**] or [**↷**].
 - The number is dialed automatically.
 - You can press a line key instead of pressing [**↶**] or [**↷**].

Editing Phonebook items

Base Unit Handset

Using the base unit

- 1 Display the desired item, as described under “Finding and calling a Phonebook item” on page 44.
- 2 Press [**EDIT**].
- 3 Edit the name, if necessary. See the character table on page 44 for character entry.
 - Pressing [**CLEAR**] erases the character to the left of the cursor. To erase all characters, press and hold [**CLEAR**].
- 4 Press [**ENTER**].
- 5 Edit the phone number, if necessary.
 - Pressing [**CLEAR**] erases the digit to the left of the cursor. To erase all digits, press and hold [**CLEAR**].
- 6 Press [**ENTER**].
 - Confirmation tone is heard.
- 7 Press [**EXIT**].

Using the cordless handset

- 1 Display the desired item as described under "Finding and calling a Phonebook item" on page 44.
- 2 Press **Edit**.
- 3 Edit the name, if necessary. See the character table on page 44 for character entry.
 - Pressing **[CLEAR]** erases the character to the left of the cursor. To erase all characters, press and hold **[CLEAR]**.
- 4 Press **Next**.
- 5 Edit the phone number, if necessary.
 - Pressing **[CLEAR]** erases the digit to the left of the cursor. To erase all digits, press and hold **[CLEAR]**.
- 6 Press **Save**.
 - Confirmation tone is heard.
- 7 Press **[OFF]**.

Erasing Phonebook items

Base Unit **Handset**

- 1 Display the desired item as described under "Finding and calling a Phonebook item" on page 44.
- 2 Press **[CLEAR]**.
 - Confirmation tone is heard.
 - To erase more items, repeat from step 2.
 - To erase the entire Phonebook, refer to page 78.

Chain dial **Base Unit** **Handset**

This feature allows you to dial phone numbers stored in the Phonebook while you are on a call. This feature can be used, for example, to dial a calling card access number or bank account PIN that you have stored in the Phonebook, without having to dial manually.

Using the base unit

- 1 During a conversation, press **[◀]** or **[▶]** to enter the Phonebook.
- 2 Press **[v]** or **[^]** repeatedly to display the desired item.
 - To search by initial see page 45.
- 3 Press **[ENTER]** to dial the number.

Using the cordless handset

- 1 During a conversation, press **[◀]** or **[▶]** to enter the Phonebook.
- 2 Press **[▲]** or **[▼]** repeatedly to display the desired item.
 - To search by initial see page 45.
- 3 Press **Call** to dial the number.

Using caller ID service

This unit is compatible with Caller ID services offered by your telephone service provider. If you subscribe to Caller ID, caller names and phone numbers will be displayed and recorded in the Caller List.

The base unit and each cordless handset can record information of up to 50 different callers in the caller list.

The Caller List information is sorted from the most recent to the oldest call. When the base unit or cordless handset receives the 51st call, the oldest call is deleted.

Using this list, you can automatically call back a caller. You can store the callers' names and numbers from the Caller List in the Phonebook.

If you subscribe to both Caller ID and Call Waiting services, when a second call is received on the same line, the new caller's name and phone number are displayed. See "For call waiting service users" on page 41.

How caller information is displayed when a call is received

When a call comes in, the unit will ring and Caller ID information will be displayed. The display shows the caller's information and the called line after the first ring.

**Example
(from the
base unit):**

```
John Smith
1-012-345-6789
-----Line 1-----
```

- After you answer the call, the display will show the length of the call.

Personalized name display

If you receive a call from one of the phone numbers stored in the Phonebook, the base unit/cordless handset will show the caller's name that has been stored in the Phonebook instead of the incoming caller ID information.

- If the unit cannot receive caller information, the following will be displayed:
 - “Out of area”: The caller dialed from an area which does not provide Caller ID service.
 - “Private caller”: The caller requested not to send caller information.
- If the unit is connected to a PBX system, caller information may not be received properly. Consult your PBX supplier.
- If two lines receive calls at the same time, each caller's information will be displayed alternately.
- The name display service may not be available in some areas. For more information, please contact your telephone service provider.
- If the cordless handset loses contact with the base unit when a call is received, the caller information will not be recorded in the cordless handset's Caller List.
- Caller ID information will not be displayed on the base unit when the automated attendant system is responding to a call (page 66). Caller ID information will be displayed on the called cordless handset or the base unit after the caller enters the extension number.
- If caller ID information has been withheld by the caller, no caller ID information will be displayed.

Caller list

The base unit and each cordless handset can record the information of up to 50 different callers in the caller list. You can use this list to return missed calls.

- Caller information includes the caller's name and phone number, the date and time the call was received, and the number of times the caller called.

Missed calls

If a call is not answered, the unit treats the call as a missed call. The number of missed calls is shown on the base unit/cordless handset's display. This lets you know if you should view the Caller List to see who called while you were out.

**Example
(from the
base unit):**

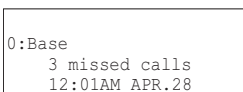

0:Base
3 missed calls
12:01AM APR.28

Viewing and calling back using the caller list

Base Unit
Handset

Using the base unit

If you have received new calls, the number of missed calls is displayed in standby mode.

- 1 Press [▼] or [▲] to enter the list.
 - The number of new calls is displayed.
 - If the Caller List is empty, "No items stored" is displayed.
- 2 Press [▼] to search from the most recent call, or press [▲] to search from the oldest call.

Example:

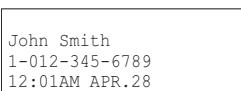

John Smith
1-012-345-6789
12:01AM APR.28

- To scroll through the list of callers, press [▼] or [▲].

- A ✓ is displayed next to items which have already been viewed.
- If the same caller calls more than once, it will be displayed with the number (for example, "x2"). Only the date and time of the most recent call will be stored.

3 Lift the handset or press [SP-PHONE].

- The displayed phone number is dialed automatically.
- You can press a line key instead of pressing [SP-PHONE].

Example:

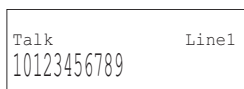

Talk Line1
10123456789

Note:

- Calling back will not be possible if the caller information does not include a phone number.
- In some cases, you may have to edit the number before dialing. (For example, you may have to delete "1" and the area code.)

Using the cordless handset

If you have received new calls, the number of new calls is displayed in standby mode.

- 1 Press [▼] or [▲] to enter the list.
 - The number of new calls is displayed.
 - If the Caller List is empty, "No items stored" is displayed.
- 2 Press [▼] to search from the most recent call, or press [▲] to search from the oldest call.

Example:



John Smith
1-012-345-6789
11:01AM APR.28
[Edit] [Save]

- To scroll through callers, press [▼] or [▲].
- A ✓ is displayed next to items which have already been viewed.
- If the same caller calls more than once, it will be displayed with the number (for

example, "x2"). Only the date and time of the most recent call will be stored.

3 Press **[↶]** or **[↷]**.

- The displayed phone number is dialed automatically.
- You can press a line key instead of pressing **[↶]** or **[↷]**.

Example:

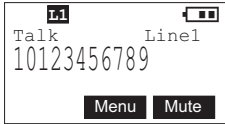

Note:

- Calling back will not be possible if the caller information does not include a phone number.
- In some cases, you may have to edit the number before dialing. (For example, you may have to delete "1" and the area code.)

Editing a caller's phone number before calling back **Handset**

Base Unit

You can edit a phone number in the caller list by removing its area code and/or the long distance code, "1".

You can also edit a phone number to store in the Phonebook (page 43).

Caller ID number auto edit feature

Once you call back an edited number, the unit will remember the area code and format of the edited number. Next time someone calls from the same area code, caller information, when reviewed from the Caller List, will be displayed in the same format as the edited number.

You can use this feature to set the unit to ignore the area code of callers in your area code, so that you can call these local numbers using caller information without dialing the area code.

To activate this feature, you must edit an item in the Caller List (see below), then call that number. After that, calls from that caller's area code will be edited automatically.

This feature can be turned on or off (page 82). The default setting is ON.

Note:

- The cordless handset and base unit can remember up to four area codes to be edited. Phone numbers from the four most recently edited area codes will be automatically edited.
- This feature will not be activated until edited numbers are called back.
- If you move to another area, you can turn this feature off to erase previously edited area codes. To use this feature again, turn it on and reprogram the area codes you want to edit once again.

- 1 Press **[▼]** or **[▲]** to enter the list.
- 2 Press **[▼]** or **[▲]** repeatedly to display the desired item.
- 3 Press **[EDIT]** repeatedly until the phone number is shown in the desired format.
 Local phone number,
 example: 321-5555
 Area code — Local phone number,
 example: 555-321-5555
 1 — Area code — Local phone number,
 example: 1-555-321-5555
- 4 If using the base unit, lift the handset or press **[SP-PHONE]**. If using the cordless handset, press **[↶]** or **[↷]**.
 - You can press a line key instead of pressing **[SP-PHONE]** or **[↷]**.

Storing caller information in the Phonebook **Handset** **Base Unit**

The base unit and cordless handset(s) can store items displayed in the Caller List in the Phonebook.

- 1 Press **[▼]** or **[▲]** to enter the list.
- 2 Press **[▼]** or **[▲]** repeatedly to display the desired item.
 - If the number requires editing, refer to page 49.
- 3 If using the base unit, press **[MENU]**. If using the cordless handset, press **Save**.
 - “Save phonebook?” is displayed.
- 4 If using the base unit, press **[ENTER]**. If using the cordless handset, press **Save**.
 - If there is no name information for the caller, “Enter name:” is displayed. Enter the name, if necessary. Followed by **[ENTER]** if using the base unit, or **Save** if using the cordless handset.
 - Confirmation tone is heard.

Note:

- If the display shows “Memory is full”, press **[EXIT]** on the base unit or **[OFF]** on the cordless handset, and erase unnecessary items from the Phonebook (page 46).
- If the caller information does not include a phone number, it cannot be stored in the Phonebook.

Erasing caller information **Handset** **Base Unit**

After checking the Caller List, the base unit and cordless handset(s) user can erase some, or all, of the items.

Erasing a selected item

- 1 Press **[▼]** or **[▲]** to enter the list.
- 2 Press **[▼]** or **[▲]** repeatedly to display the desired item.
- 3 Press **[CLEAR]**.
 - Confirmation tone is heard.
 - To erase other items, repeat from step 2.
 - To return to standby mode, press **[EXIT]** on the base unit or **[OFF]** on the cordless handset.

Erasing all items

Note:

- Make sure that you have no missed calls.
- 1 Press **[▼]** or **[▲]** to enter the list.
 - 2 If using the base unit:
Press **[CLEAR]** twice.
OR
If using the cordless handset:
Press **Erase**, followed by **Yes**.
 - Confirmation tone is heard.

Voice Mail System

The Voice Mail System allows you to receive and deliver voice messages using mailboxes. The unit accommodates one general delivery mailbox and a maximum of eight personal mailboxes which are assigned to the registered cordless handsets. The mailbox numbers are the same as the cordless handset numbers. The Voice Mail System works fully with the Automated Attendant System, which routes incoming calls to a specified mailbox and allows a caller to leave a message (page 66). If a caller does not specify a mailbox, the call is routed to the general delivery mailbox. With the Answering System (page 71), all calls are routed to the general delivery mailbox. You can set either the Automated Attendant System or the Answering System to any line.

If you change the display language (page 24), all voice prompts are heard in the selected language.

Note:

- The maximum number of personal mailboxes you can use is equal to the number of registered cordless handsets.

The base unit and cordless handset users can use the Voice Mail System by accessing their mailboxes. Each cordless handset user can only access his/her own mailbox. The general delivery mailbox is managed by the base unit user (operator). The cordless handset users can access this mailbox. The following functions are possible:

- listening to messages (pages 52 and 55);
- transferring a message to other mailboxes (pages 54 and 64);
- delivering your own message to other mailboxes (page 57).

You can also access the Voice Mail System's features remotely from a touch tone phone (page 63).

Note:

- All messages (greetings, incoming, etc.) and two way recordings, are stored in digital memory. **The total recording time is approximately 100 minutes.** The maximum recording time for each call is three minutes. A maximum of 255 messages (including greeting messages) can be recorded.
- The base unit user can monitor incoming calls that are being recorded in the general delivery mailbox (page 86).
- The base unit user can check the remaining recording time and number of messages which can still be recorded (page 59).

Setting the mailbox password

Base Unit Handset

To prevent unauthorized people accessing mailboxes and listening to messages remotely from a touch tone phone, assign a 4-digit password (0000-9999) to each mailbox. The default password for the general delivery mailbox is "0000". The preset password for each mailbox is a 4-digit number using the mailbox number (Example: "1111" for Mailbox 1, "2222" for Mailbox 2). Each password must be unique.

The general mailbox password must be set using the base unit. Personal mailbox passwords must be set using cordless handsets.

Setting the general mailbox password using the base unit

- 1 Press **[MENU]**.
- 2 Scroll to "Initial setting" by pressing **[V]** or **[^]**, then press **[ENTER]**.

Voice Mail System

3 Scroll to “**Mailbox**” by pressing [V] or [^], then press [ENTER].

4 Scroll to “**Set password**” by pressing [V] or [^], then press [ENTER].

- The current password is displayed.
- If the password has already been set correctly, press [ENTER] to leave the password unchanged and proceed to the completion screen.

5 Enter a 4-digit password.

- If you enter an incorrect digit, press [CLEAR], and enter the digit again. To delete the entire password, press and hold [CLEAR] for three seconds.

6 Press [ENTER].

- Confirmation tone is heard.

Note:

- To check the password, repeat step 1 to step 4 to display the password. When finished, press [EXIT].

Setting a personal mailbox password and direct handset access using a cordless handset

Direct handset access mode can be set to OFF on any cordless handset. When set to OFF, no one can access personal mailbox messages or features without entering the password. Your cordless handset comes from the factory set to ON.

1 Press **Menu**.

2 Scroll to “**Initial setting**” by pressing [v] or [^], then press **Select**.

3 Scroll to “**Mailbox**” by pressing [v] or [^], then press **Select**.

4 Scroll to “**Set password**” by pressing [v] or [^], then press **Select**.

- The current password is displayed.
- If the password has already been set correctly, press **Next** to leave the password unchanged and proceed to step 7.

5 Enter a 4-digit password.

- If you enter an incorrect digit, press **Clear**, and enter the digit again. To delete the entire password, press and hold **Clear** for three seconds.

6 Press **Next** to save the new password.

7 Press [v] or [^] to select whether to turn the direct handset access ON or OFF.

8 Press **Save** to save the direct handset access setting.

- Confirmation tone is heard.

Note:

- To check the password, repeat step 1 to step 4 to display the password. When finished, press [OFF].

Listening to messages from the base unit **Base Unit**

If the ☒ indicator flashes, a new message has been received in the general delivery mailbox.

The base unit user (operator) is responsible for handling the following aspects of the general delivery mailbox:

- Checking the mailbox for messages and transferring them to the appropriate mailboxes.
- Erasing unnecessary messages.

Note:

- When there is no storage space left for new messages, the base displays “**Message full**”.
- When there is available recording space for less than ten messages, the base displays “**Message space: 9msg**”.
- When available recording time is less than ten minutes, the base displays “**Message space: 9min**”.

During playback the ☒ indicator lights.

Listening to only new messages

- 1 While in standby mode and the ☒ indicator is flashing, press ☒.
 - “*This is the general delivery mailbox.*” is announced.
 - If there is one new message, “*You have one new message.*” is announced.
 - If there is more than one new message, “*You have <number> new messages.*” is announced.
 - If you have more than 100 new messages, “*You have more than 100 new messages.*” is announced.
 - If you have no new messages, “*You have no new messages.*” is announced.
- 2 New messages are played.
 - The first message is played back, and the message number is displayed. The name and number are displayed if you have subscribed to Caller ID services (page 47).
 - For each message “*Message recorded on <date> at <time>.*” is announced, followed by confirmation tone.
 - After each message playback, the next message plays.
 - Press [◀] or [▶] to repeat the current message or move on to the next message, as required. Before the current message is repeated, “*Repeat*” is announced. Before the next message is played, “*Next*” is announced.
 - After the last message is played, “*This is the last message.*” is announced.
- 3 Press [EXIT] to return to standby mode.

Listening to all messages

- 1 While the base unit is in standby mode, press ☒.
 - “*This is the general delivery mailbox.*” is announced.
 - If there is one new message, “*You have one new message.*” is announced.
 - If there is more than one new message, “*You have <number> new messages.*” is announced.
 - If you have more than 100 new messages, “*You have more than 100 new messages.*” is announced.
 - If you have no new messages, “*You have no new messages.*” is announced.
- 2 Scroll to “**Play all messages**” by pressing [v] or [^], then press [ENTER].
 - If you have messages, “*You have <number> messages.*” is announced.
 - All messages are played.
 - If there are no messages, “*There are no messages.*” is announced.
 - The first message is played back, and the message number is displayed. The name and number are displayed if you have subscribed to Caller ID services (page 47).
 - For each message, “*Message recorded on <date> at <time>.*” is announced, followed by confirmation tone.
 - Press [◀] or [▶] to repeat the current message or move on to the next message, as required. Before the current message is repeated, “*Repeat*” is announced. Before the next message is played, “*Next*” is announced.
 - After the last message is played, “*This is the last message.*” is announced.
- 3 Press [EXIT] to return to standby mode.

Calling back a caller who left a message

This feature allows you to call back the caller who left a recorded message.

Note:

- This option is only available if you have subscribed to Caller ID services (page 47).

1 While a message is being played back, press **[SP-PHONE]**, lift the handset or press a line key.

- The unit stops playback and the caller is automatically called back.

2 Continue the call as normal.

Transferring a message

While listening to a message, you can transfer it to other mailboxes.

1 During playback, enter the destination mailbox number(s) using the **[INTERCOM]** keys **[1]** to **[8]**.

- “*Enter the destination mailbox number.*” is announced.
- Press **[INTERCOM ALL]** to select all mailboxes.
- Press **[CLEAR]** to erase the displayed mailbox number.

2 Press **[ENTER]**.

- “*Message transferred via mailbox <mailbox number> and mailbox <mailbox number>...*” is announced.
- If there is a message after the transferred message it will be played.
- After the last message is played, “*This is the last message.*” is announced.
- If you enter your own mailbox number, “*This is your mailbox.*” is announced.
- If an invalid mailbox number is entered, “*Incorrect entry.*” is announced.

Erasing a message

We recommend that you erase unnecessary messages after each playback.

1 While a message is being played back, press **[CLEAR]**.

- “*Message erased.*” is announced.
- Confirmation tone is heard.

Listening to personal mailbox messages from the base unit

If the cordless handset battery has no power or the cordless handset cannot be used for some reason, you (or the operator) can access your mailbox from the base unit.

Note:

- The base unit cannot access an unregistered cordless handset's mailbox.

1 From the base unit, press **[☒]**.

2 Select the cordless handset's mailbox that you wish to access, by pressing **[INTERCOM] [1]** to **[8]**.

3 Enter the corresponding cordless handset's mailbox password, if requested (page 51).

4 Press **[ENTER]**.

- “*Mailbox <mailbox number>.*” is announced.
- If an invalid mailbox number is entered, “*Incorrect entry.*” is announced, and “**Invalid mailbox**” is displayed.
- If the mailbox chosen is in use, “*Sorry, this mailbox is in use.*” is announced and displayed.
- You can listen to all messages (page 55), and create and send messages (page 57).
- To end the operation, press **[EXIT]**.

Listening to messages with the cordless handset **Handset**

You can access your cordless handset mailbox and listen to messages, transfer messages to other mailboxes and erase unnecessary messages. You can also access the general delivery mailbox from your cordless handset.

If the  indicator and the antenna flash, new messages have been received in your mailbox. During playback the message indicator lights.

Listening to new messages

- 1 While in standby mode, press **M.box**.
 - If direct handset access is disabled (off), the Set Password screen is displayed. Enter the password as described under "Setting the mailbox password" on page 51.
 - "Mailbox <mailbox no>." is announced.
 - If there is one new message, "You have one new message." is announced.
 - If there is more than one new message, "You have <number> new messages." is announced.
 - If you have more than 100 new messages, "You have more than 100 new messages." is announced.
 - If you have no new messages, "You have no new messages." is announced.
- 2 New messages are played.
 - The first message is played back, and the message number is displayed. The name and number are displayed, if you have subscribed to Caller ID services (page 47).
 - For each message "Message recorded on <date> at <time>." is announced, followed by confirmation tone.
 - Press [**◀**] or [**▶**] to repeat the current message or move on to the next message, as required. Before the current message is repeated, "Repeat" is announced. Before the next message is played, "Next" is announced.

- After the last message is played, "This is the last message." is announced.

- 3 Press [**OFF**] to return to standby mode.

Listening to all messages

- 1 While in standby mode, press **M.box**.
 - If direct handset access is disabled (off), the Set Password screen is displayed. Enter the password as described in "Setting the mailbox password" on page 51.
 - "Mailbox <mailbox no>." is announced.
 - If there is one new message, "You have one new message." is announced.
 - If there is more than one new message, "You have <number> new messages." is announced.
 - If you have more than 100 new messages, "You have more than 100 new messages." is announced.
 - If you have no new messages, "You have no new messages." is announced.
- 2 Scroll to "Play all msg." by pressing [**▼**] or [**▲**], then press **Select**.
 - If you have messages, "You have <number> messages." is announced.
 - All messages are played.
 - The first message is played back, and the message number is displayed. The name and number are displayed, if you have subscribed to Caller ID services (page 47).
 - For each message "Message recorded on <date> at <time>." is announced, followed by confirmation tone.
 - Press [**◀**] or [**▶**] to repeat the current message or move on to the next message, as required. Before the current message is repeated, "Repeat" is announced. Before the next message is played, "Next" is announced.
 - After the last message is played, "This is the last message." is announced.
- 3 Press [**OFF**] to return to standby mode.

Calling back a caller who left a message

This feature allows you to call back a caller who left a message.

Note:

- This option is only available if you have subscribed to Caller ID services (page 47).

1 While a message is being played back, press [↩], [↶] or press a line key.

- Playback stops and caller is automatically called back.

2 Continue the call as normal.

Transferring a message

While listening to a message, you can transfer it to other mailboxes.

1 During playback, press [INTERCOM].

- “Enter the destination mailbox number.” is announced.

2 Scroll to the required cordless handset(s) or the base by pressing [▼] or [▲]. Press [OK] to select the highlighted recipient. Continue until all recipients are selected.

- Alternatively, key-in the desired cordless handset number using the keypad keys ([0] to [8]). For the general delivery mailbox, press [0].
- Press [*] to select all available cordless handsets/base.
- ✓ is displayed against selected cordless handset(s)/base.
- The current cordless handset is not displayed.
- Press [CLEAR] to erase the displayed mailbox number.

3 Press [Select].

- “Message transferred via mailbox <mailbox number> and mailbox <mailbox number>...” is announced.
- If there is a message after the transferred message, it will be played.
- After the last message is played, “This is the last message.” is announced.

Erasing a message

We recommend that you erase unnecessary messages after each playback.

While the message you want to erase is being played or before the start of the next message, press [Erase].

- “Message erased.” is heard, followed by confirmation tone. The next message is played.
- After the last message is played, “This is the last message.” is announced.

Listening to messages in the general delivery mailbox

You can access the general delivery mailbox from your cordless handset.

1 While in standby mode, press [M.box].

2 Scroll to “General mailbox” by pressing [▼] or [▲], then press [Select].

- The current settings are displayed, and “This is the general delivery mailbox.” is announced.
- You can listen to all messages (old and new) as described on page 52.
- To exit the general mailbox, scroll to “Return mailbox” followed by [Select].
- If the general delivery mailbox is in use when access is attempted, “Sorry, this mailbox is in use.” is announced.

Creating and sending messages

Base Unit Handset

The base unit user or cordless handset user can send an identical message of **up to three minutes**, to several mailboxes in a single operation.

Using the base unit

- 1 While in standby mode, press **[☒]**.
 - “*This is the general delivery mailbox.*” is announced.
 - If there is one new message, “*You have one new message.*” is announced.
 - If there is more than one new message, “*You have <number> new messages.*” is announced.
 - If you have more than 100 new messages, “*You have more than 100 new messages.*” is announced.
 - If you have no new messages, “*You have no new messages.*” is announced.
- 2 Scroll to “**Deliver message**” by pressing **[v]** or **[^]**, then press **[ENTER]**.
 - “*Enter the destination mailbox number.*” is announced.
- 3 Key-in the desired mailbox number using the corresponding keypad keys (**[0]** to **[8]**), or **[INTERCOM]** **[1]** to **[8]**.
 - Press **[INTERCOM ALL]** to select all mailboxes, press it again to de-select all mailboxes.
 - Press **[CLEAR]** to erase the displayed mailbox number.
- 4 Press **[ENTER]**.
 - “*Message record*” is displayed.
- 5 Press **[▶]**.
 - “*Please leave a message at the tone. To end recording, press 1.*” is announced.
- 6 After the tone, talk clearly, about 8 inches (20 cm) away from the microphone. To end, press **[1]**.

- To change the message, press **[1]** and record the message again.
- After recording “*The message is*” is announced followed by the recorded message.

- 7 Press **[2]** to accept the recording.
 - The message is automatically delivered to the specified mailbox.
 - “*Message transferred via mailbox <mailbox number> and mailbox <mailbox number>...*” is announced.
 - If an invalid mailbox is entered in step 3, “*Incorrect entry.*” is announced. Key-in the correct mailbox number at the prompt.

Note:

- If the elapsed recording time exceeds three minutes, recording will stop.

Using the cordless handset

- 1 While in standby mode, press **M.box**.
 - If the direct handset access mode is OFF (page 52), enter the mailbox password, then press **Next**.
 - If you have new messages, listen to all of them.
 - “*Mailbox <mailbox number>.*” is announced.
 - If there is one new message, “*You have one new message.*” is announced.
 - If there is more than one new message, “*You have <number> new messages.*” is announced.
 - If you have more than 100 new messages, “*You have more than 100 new messages.*” is announced.
 - If you have no new messages, “*You have no new messages.*” is announced.
- 2 Scroll to “**Deliver msg.**” by pressing **[v]** or **[^]**, then press **Select**.
 - “*Enter the destination mailbox number.*” is announced.
 - Unregistered cordless handsets are not displayed.

3 Scroll to the required mailbox number by pressing [▼] or [▲]. Press [MENU] to select the highlighted recipient. Continue until all recipients are selected.

- Alternatively, key-in the desired mailbox number using the keypad keys ([0] to [8]). For the general delivery mailbox, press [0].
- Press [*] to select all available cordless handsets and the base.
- ✓ is displayed against the selected cordless handset(s)/base.
- Press [CLEAR] to erase the current selection.

4 Press [Select].

- "Message record" is displayed.

5 Press [Start].

- "Please leave a message at the tone. To end record, press End." is announced.

6 After the tone, talk clearly. To end, press [End].

- After recording "The message is" is announced followed by the recorded message.
- To change the message, press [Change] and record the message again.

7 Press [OK] to accept the recording.

- The message is automatically delivered to the specified mailbox.
- "Message transferred via mailbox <mailbox number> and mailbox <mailbox number>..." is announced.

Note:

- If the elapsed recording time exceeds three minutes, recording will stop.

Transferring a call to a personal mailbox **Base Unit** **Handset**

After the base unit user (operator) answers an incoming call, the call can be transferred to the general mailbox where the caller can leave a message.

- If the line's Answer ON status is idle or the Mailbox is on, transferred calls are sent to the General Delivery Mailbox.
- If the line's Answer ON status is Auto Attendant ON, calls are directed to the Auto Attendant, where the caller hears the pre-recorded or user-defined message.

To transfer a call to voice mail from the base unit

When answering a call, you may tell the caller that the person they wish to speak to is unavailable, then press ☒, and hang up.

- The caller will then hear the line's greeting message. While the greeting is playing, the caller can press the extension number ([1] to [8]) followed by [¶].
 - If the cordless handset answer mode of the extension is on (page 62), the caller will hear the personal greeting message at the end of the second ring, then he/she can leave a message at the tone.
 - If the cordless handset answer mode is off (page 62), the caller will hear "Sorry, no one is available to answer the call. To leave a message, press 1. To call another extension, press 2. To call the operator, press 0." at the end of the fifth ring.

Note:

- If the line setting is set to AUTO ATTENDANT ON, the caller is directed to the auto attendant.

To transfer a caller to voice mail from a cordless handset

- 1 During a call, press **[INTERCOM]/[HOLD]/[TRANSFER]**.
- 2 Press **[▼]** or **[▲]** to scroll to "Mailbox" or press **[9]**.
- 3 Press **Select**.
 - The call is transferred to the general mailbox.

Note:

- If the line setting is set to AUTO ATTENDANT ON, the caller is directed to the auto attendant.

Checking the remaining recording time and number of messages **Base Unit**

If the remaining recording time is less than ten minutes or the number of messages which can still be recorded is less than ten, the base unit will display the time or number while in standby mode.

- 1 While in standby mode, press **[MENU]**.
- 2 Scroll to "Initial setting" by pressing **[▼]** or **[▲]**, then press **[ENTER]**.
- 3 Scroll to "Mailbox" by pressing **[▼]** or **[▲]**, then press **[ENTER]**.
- 4 Scroll to "Remaining space" by pressing **[▼]** or **[▲]**, then press **[ENTER]**.

Example:

```
Remaining space
Time       : <1min
Messages  : 100
```

- The current settings are displayed. The display returns to the previous screen after two seconds.

Erasing all messages stored in a mailbox **Base Unit**

The base unit user can erase all incoming messages in any mailbox. Inform the mailbox owner(s) before erasing, and check that there are no new messages in the mailbox(es).

- 1 While in standby mode, press **[MENU]**.
- 2 Scroll to "Initial setting" by pressing **[▼]** or **[▲]**, then press **[ENTER]**.
- 3 Scroll to "Initialize base" by pressing **[▼]** or **[▲]**, then press **[ENTER]**.
- 4 Scroll to "Messages" by pressing **[▼]** or **[▲]**, then press **[ENTER]**.
- 5 Select the mailbox(es) to delete using the corresponding keypad keys **[0]** to **[8]**. You can also use the **[INTERCOM]** keys. Select all mailboxes by pressing the **[INTERCOM ALL]** key.

Note:

- Pressing a key toggles the current setting. For example, press **[1]** once to select mailbox 1, then press it again to de-select.
 - Pressing a key for an invalid mailbox will result in an error tone.
- 6 When all valid mailbox numbers have been entered, press **[▶]**.
 - 7 Select whether to delete just messages, or messages and greetings by pressing **[▼]** or **[▲]**.
 - 8 Press **[CLEAR]** to complete the operation.
 - Confirmation tone is heard.

User greetings **Base Unit**

You can create up to five user greetings for the base unit.

Note:

- The maximum length of a stored user greeting is two minutes.

Creating a greeting

- 1 Press the **[ANSWER ON]** key.
- 2 Scroll to “**Setup**” by pressing **[V]** or **[^]**, then press **[ENTER]**.
- 3 Scroll to “**User greetings**” by pressing **[V]** or **[^]**, then press **[ENTER]**.
- 4 Scroll to the required greeting message by pressing **[V]** or **[^]**, then press **[ENTER]**.
 - The selected greeting is played, if stored.
- 5 If a greeting has not been stored, press **[▶]** to start recording.
- 6 Press **[1]** to finish recording.
 - The newly recorded greeting message is played back.
- 7 Press **[1]** to change the greeting or **[2]** to accept the greeting.
 - Confirmation tone is heard if you accept the greeting.

Playing a greeting

- 1 Press the **[ANSWER ON]** key.
- 2 Scroll to “**Setup**” by pressing **[V]** or **[^]**, then press **[ENTER]**.
- 3 Scroll to “**User greetings**” by pressing **[V]** or **[^]**, then press **[ENTER]**.
- 4 Scroll to the required greeting message by pressing **[V]** or **[^]**, then press **[ENTER]**.
 - The selected greeting is played.

Erasing a greeting

- 1 Press the **[ANSWER ON]** key.
- 2 Scroll to “**Setup**” by pressing **[V]** or **[^]**, then press **[ENTER]**.
- 3 Scroll to “**User greetings**” by pressing **[V]** or **[^]**, then press **[ENTER]**.
- 4 Scroll to the required greeting message by pressing **[V]** or **[^]**, then press **[ENTER]**.
 - The selected greeting is played.
- 5 While the current greeting is being announced, press **[CLEAR]**.

Personal greetings **Base Unit** **Handset**

You can create a greeting for each cordless handset.

You can play, record and erase a cordless handset's personal greeting from the base unit.

Note:

- If you receive an incoming call while recording a greeting, recording stops. The base unit/cordless handset returns to standby mode, and you can answer the call in the usual way (page 32).

Playing a handset's personal greeting from the base unit

- 1 While in standby mode, press **☒**.
- 2 Enter the required handset number using the **[INTERCOM]** keys **[1]** to **[8]**.
- 3 Key-in the handset's password.
- 4 Scroll to “**Personal greeting**” by pressing **[V]** or **[^]**, then press **[ENTER]**.
 - “*Personal greeting is*” is announced, followed by the personal greeting, if stored. If a personal greeting has not

been stored, the pre-recorded greeting is played.

Creating a personal greeting from the base unit

- 1 While in standby mode, press **☒**.
- 2 Enter the required handset number using the **[INTERCOM]** keys **[1]** to **[8]**.
 - The required mailbox must be registered and not in use.
- 3 Key-in the handset's password, then press **[ENTER]**.
- 4 Scroll to "Personal greeting" by pressing **[V]** or **[^]**, then press **[ENTER]**.
 - "Personal greeting is" is announced, followed by the personal greeting, if stored. If a personal greeting has not been stored, the pre-recorded greeting is played.
- 5 Press **[1]** to change the greeting, followed by **[▶]** to start recording.
- 6 Press **[1]** to finish recording.
 - The newly recorded greeting message is played back.
- 7 Press **[1]** followed by **[▶]** to change the greeting, or **[2]** to accept the greeting.
 - Confirmation tone is heard if you accept the greeting.

Erasing a personal greeting from the base unit

Note:

- This option is not available when the pre-greeting is set.

- 1 While in standby mode, press **☒**.
- 2 Enter the required handset number using the **[INTERCOM]** keys **[1]** to **[8]**.
- 3 Key-in the handset's password.

- 4 Scroll to "Personal greeting" by pressing **[V]** or **[^]**, then press **[ENTER]**.

- "Personal greeting is" is announced, followed by the personal greeting, if stored.

- 5 While the current greeting is being announced, press **[CLEAR]**.

- "Message erased" is announced.

Playing a personal greeting from a cordless handset

- 1 Press **M.box**.
- 2 Scroll to "Personal greet" by pressing **[v]** or **[^]**, then press **Select**.
 - "Personal greeting is" is announced, followed by the personal greeting.
- 3 Press **OK** to accept the greeting.
 - Confirmation tone is heard.

Creating a personal greeting from a cordless handset

- 1 Press **M.box**.
- 2 Scroll to "Personal greet" by pressing **[v]** or **[^]**, then press **Select**.
 - "Personal greeting is" is announced, followed by the personal greeting.
- 3 Press **Change** to change the current greeting.
- 4 Press **Start**.
 - "Record greeting at the tone. To end recording, press End." is announced.
- 5 Record your personal greeting after the tone.
- 6 Press **End** to finish recording.
 - "Personal greeting is" is announced, followed by the personal greeting.
- 7 Press **Change** to modify the greeting or **OK** to accept the greeting.
 - If you press **OK**, confirmation tone is heard.

Erasing a personal greeting using a cordless handset

This feature enables you to erase a user-defined greeting.

Note:

- This option is not available when a pre-greeting is set.

- 1 Press **M.box**.
- 2 Scroll to “**Personal greet**” by pressing **[▼]** or **[▲]**, then press **Select**.
 - “*Personal greeting is*” is announced, followed by the personal greeting.
- 3 While the current greeting is being announced, press **[CLEAR]**.
 - “*Message erased.*” is announced.

Turning the cordless handset answer mode on or off

Base Unit **Handset**

Handset answer mode can be turned ON or OFF either at the base unit, or using the handset.

When set to ON, incoming calls are handled by the answering system and callers may leave a message. Handsets ring as normal when answer mode is set to OFF.

Setting handset answer mode using the base unit

- 1 While in standby mode, press **☒**.
- 2 Enter the required handset number using the **[INTERCOM]** keys **[1]** to **[8]**.
- 3 Key-in the handset’s password, then press **[ENTER]**.
- 4 Scroll to “**Answer on/off**” by pressing **[V]** or **[^]**, then press **[ENTER]**.
- 5 Select “**on**” or “**off**” by pressing **[V]** or **[^]**, then press **[ENTER]**.
 - Confirmation tone is heard.

Setting handset answer mode using the cordless handset

- 1 Press **M.box**.
- 2 Scroll to “**Answer on/off**” by pressing **[▼]** or **[▲]**, then press **Select**.
- 3 Select “**on**” or “**off**” by pressing **[▼]** or **[▲]**, then press **Save**.
 - Confirmation tone is heard.

Remote access

You can access the Voice Mail System from any touch-tone phone if the Automated Attendant System or the Answering System is on for any of the lines. You can listen to recorded messages in your mailbox and the general delivery mailbox, transfer messages and send messages to other mailboxes.

When you access your mailbox, you are required to enter the mailbox password (page 51).

Note:

- The Automated Attendant System and Answering System cannot be turned on from a remote location.

Accessing the voice mail system remotely

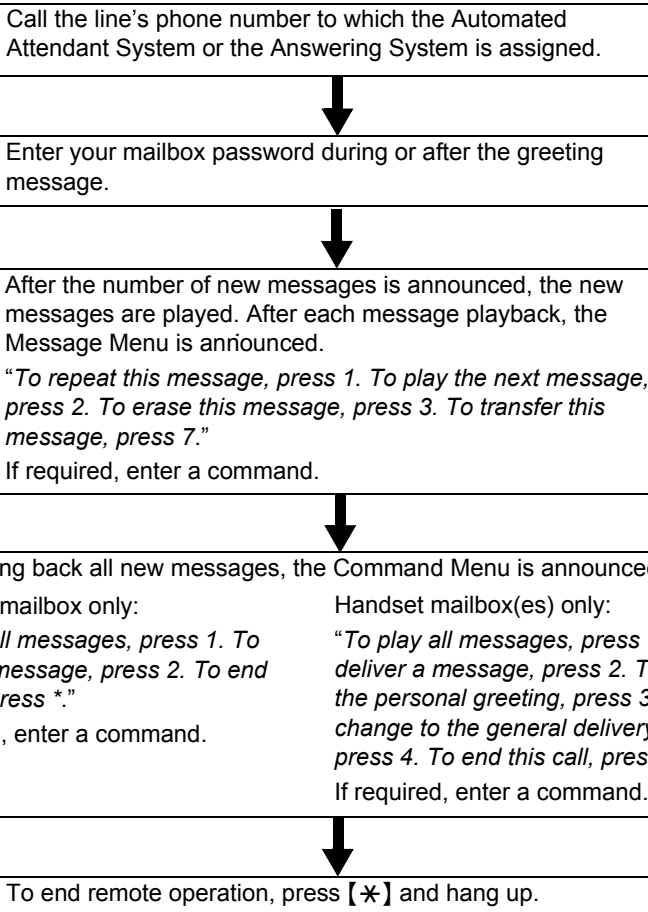

Remote access

Accessing the general mailbox remotely

- 1 While the user greeting is being played to an outside line, enter the general mailbox's registered password.
 - "This is the general delivery mailbox. Press 1 for English. Presione 2 para el Espanol." is announced.
- 2 Press **[1]** for English prompts, or press **[2]** for Spanish prompts.
 - If you do not enter a digit within four seconds, the prompts default to English.

Note:

- If you attempt to access the general mailbox while it is in use by another user, "Sorry, this mailbox is in use." is announced, and the call is terminated.

Accessing your personal mailbox remotely

- 1 While the user greeting is being played to an outside line, enter your personal mailbox's registered password.
 - "Mailbox <number>. Press 1 for English. Presione 2 para el Espanol." is announced.
- 2 Press **[1]** for English prompts, or press **[2]** for Spanish prompts.
 - If you do not enter a digit within four seconds, the prompts default to English.

Note:

- If you attempt to access your personal mailbox while it is in use by another user, "Sorry, this mailbox is in use." is announced, and the call is terminated.

While listening to messages

During playback, or before the start of the next new message:

- To repeat the message, press **[1]**.
- To play the next message, press **[2]**.
- To erase the message, press **[3]**.
- To transfer the message, press **[7]**.

Transferring a message

While listening to a message, you can transfer it to other mailboxes.

- 1 During playback, or before the start of the next message, press **[7]**.
 - "Enter the destination mailbox number." is announced.
- 2 Enter the destination mailbox(es) using the corresponding dialing keys (**[0]**, **[1]** to **[8]**). For the general delivery mailbox, press **[0]**.
 - If an invalid mailbox number is entered, "Incorrect entry." is announced.
- 3 Press **[#]** to accept.
 - The message is transferred to the selected mailbox(es).

Delivering your own message

You can send an identical message, of up to three minutes in length, to several mailboxes.

- 1 While the Command Menu is being announced (page 63), press **[2]**.
 - "Enter the destination mailbox number." is announced.
- 2 Enter the destination mailbox number(s) using the corresponding dialing keys (**[0]**, **[1]** to **[8]**). For the general delivery mailbox, press **[0]**.
 - If an invalid mailbox number is entered, "Incorrect entry." is announced.
- 3 Press **[#]** to accept.
 - "Please leave a message at the tone. To end recording, press 1." is announced.

- 4 Talk clearly after the tone. To end, press **[1]**.
 - “*The message is...*” is announced, followed by the new message.
 - “*To change, press 1. To accept, press 2.*” is announced.
- 5 To accept, press **[2]**.
 - If **[1]** is pressed, the recording process restarts.
 - Confirmation tone is heard and the message is sent to the chosen mailbox(es).
- 6 While the Command Menu is being announced, press **[✳]** and hang up.

Changing the personal greeting message (for personal mailboxes only)

You can change the mailbox personal greeting message.

- 1 While the Command Menu is being announced (page 63), press **[3]**.
 - The current personal greeting is played.
 - “*To change, press 1. To accept, press 2. To erase, press 3.*” is announced.
- 2 Press **[1]**.
 - “*Record greeting at the tone. To end recording, press 1.*” is announced.
- 3 Talk clearly after the tone. To end, press **[1]**.
- 4 To accept, press **[2]**.
 - Confirmation tone is heard.
- 5 While the Command Menu is being announced, press **[✳]** and hang up.

Switching to the general delivery mailbox from your personal mailbox

After entering your mailbox, you can switch to the general delivery mailbox to listen to messages.

- 1 While the Command Menu is being announced (page 63), press **[4]**.
 - “*This is the general delivery mailbox.*” is announced.
 - After the number of new messages is announced, new messages are played.
- 2 After listening to all new messages, the following is announced: “*To play all messages, press 1. To deliver a message, press 2. To end this call, press *.*”

Calling the Answering System to leave a message in the general delivery mailbox without entering the password

Press **[✳]** twice during the greeting message. The unit skips the rest of the message, and you can leave your message after the tone.

Automated Attendant System

How the Automated Attendant System works

The Automated Attendant System is a flexible communication tool that can enhance your productivity by improving your call management. The Automated Attendant answers incoming calls and then routes the callers to the base unit or the desired cordless handset.

The base unit plays the role of operator with the cordless handsets as the extensions. The extension numbers are the same as the cordless handset numbers (page 25). Callers can reach the desired mailbox using the Automated Attendant System to leave messages.

The Automated Attendant System can be assigned to any line (page 67).

If you change the display language (page 24), all voice prompts are heard in the selected language.

Calling the Automated Attendant

When a caller calls a line to which the Automated Attendant System is assigned, the caller will first hear a greeting message. You can record this message yourself or use the pre-recorded message (page 67).

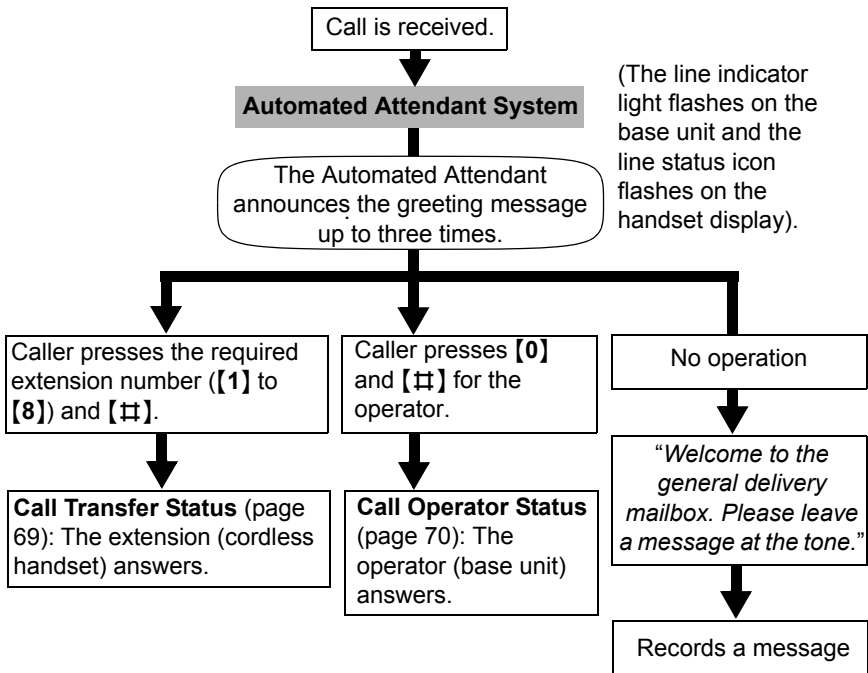

If callers select neither extension nor operator, or call from rotary telephones, the greeting message will be repeated three times, and then they will be transferred to the general delivery mailbox where they can leave messages.

Setting the Automated Attendant System **Base Unit**

The Automated Attendant System can be assigned to any line. You can record up to five greeting messages of up to two minutes each. The same messages can be used for the Answering System (page 71).

Note:

- Try to record brief messages to leave more time for recording new messages.

The following greeting message is pre-recorded:

"Hello, this is Automated Attendant System. Press 1 for English. Presione 2 para el Espanol. Please enter your party's extension, followed by #. If you are using a rotary telephone, please stay on the line."

Turning on the Automated Attendant System

- 1 Press the line's **[ANSWER ON]** key.
- 2 Scroll to "**Auto attendant**" by pressing **[V]** or **[^]**, then press **[ENTER]**.
 - The current greeting is played.
 - The line indicator icon is displayed.

Selecting the pre-recorded greeting message

- 1 Press the line's **[ANSWER ON]** key.
 - The current setting is displayed.
- 2 Select "**Setup**" by pressing **[V]** or **[^]**, then press **[ENTER]**.
- 3 Select "**Auto attendant**" by pressing **[V]** or **[^]**, then press **[ENTER]**.
- 4 Select "**Select greeting**" then press **[ENTER]**.
- 5 Select "**Prerecord**", then press **[ENTER]**.
 - The pre-recorded message is played.

Recording a user greeting message

- 1 Press the line's **[ANSWER ON]** key.
 - The current setting is displayed.
- 2 Select "**Setup**" by pressing **[V]** or **[^]**, then press **[ENTER]**.
- 3 Select "**User greetings**" by pressing **[V]** or **[^]**, then press **[ENTER]**.
- 4 Select a greeting, "**Greeting 1**" to "**Greeting 5**" by pressing **[V]** or **[^]**, then press **[ENTER]**.
 - The current user greeting message is played, if stored.
 - If a greeting has not been stored, "**(none)**" is displayed against the greeting.
- 5 Press **[▶]** to start recording.
- 6 After the tone, talk clearly, about 8 inches (20 cm) away from the microphone (see page 18 for its location). To end, press **[1]**.
 - If the elapsed recording time exceeds two minutes, the unit will stop recording.
 - The recorded message will be played.
 - To change the message, press **[1]** and restart from step 5.
- 7 Press **[2]** to accept the recorded message.

Selecting/changing the recorded message

- 1 Press the line's **[ANSWER ON]** key.
- 2 Scroll to "**Setup**" by pressing **[V]** or **[^]**, then press **[ENTER]**.
- 3 Scroll to "**User greetings**" by pressing **[V]** or **[^]**, then press **[ENTER]**.
- 4 Select "**Greeting 1**" to "**Greeting 5**" by pressing **[V]** or **[^]**, then press **[ENTER]**.
 - The current greeting is played.

Automated Attendant System

5 To accept the message, press **[2]**.

Or:

To change the message:

Press **[1]**. Press **[▶]** to start recording.

After the tone, talk into the microphone.

To end, press **[1]**. Press **[2]** to accept the message.

Erasing a user greeting message

- 1** Press the line's **[ANSWER ON]** key.
 - The current setting is displayed.
- 2** Select "Setup" by pressing **[V]** or **[^]**, then press **[ENTER]**.
- 3** Select "User greetings" by pressing **[V]** or **[^]**, then press **[ENTER]**.
- 4** Select the user greeting you intend to erase, "Greeting 1" for instance, by pressing **[V]** or **[^]**, then press **[ENTER]**.
- 5** While the user greeting is playing, press **[CLEAR]** to erase the greeting.

Turning off the automated attendant system

- 1** Press the line's **[ANSWER ON]** key.
 - The current setting is displayed.
- 2** Select "off" by pressing **[V]** or **[^]**, then press **[ENTER]**
 - The Auto Attendant System turns off.

Call transfer status

When a caller specifies an extension by pressing the extension number ([1] to [8]) followed by [#], the call is connected to that extension, and the extension can take the call. If the extension user is engaged in another call or does not answer, a list of options (Incomplete Call Handling Menu) is announced to guide the caller. If the cordless handset answer mode is ON, the caller can leave a message in the mailbox.

If a caller presses an invalid extension number, "Sorry, this number is not assigned" is announced. The caller can call the operator or another extension, or leave a message in the general delivery mailbox following the Incomplete Call Handling Menu.

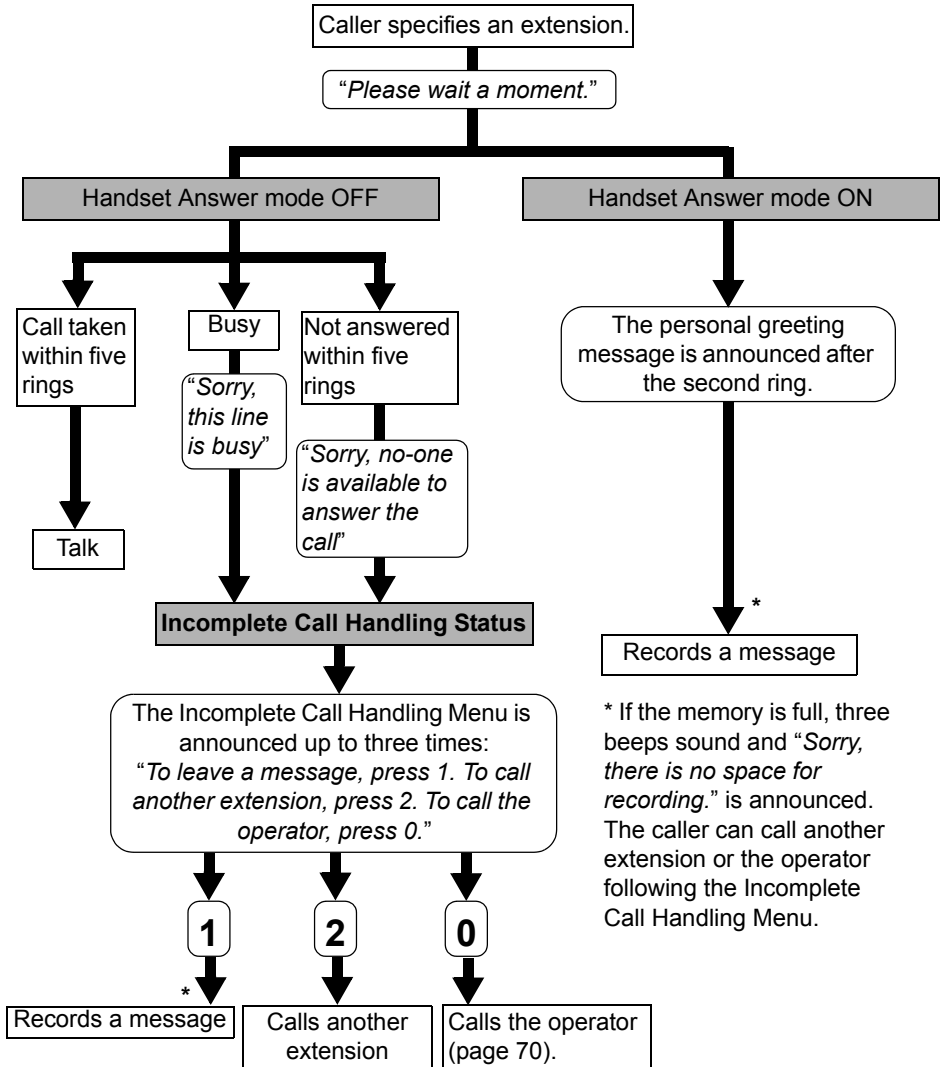

Call operator status

When a caller specifies the operator by pressing **[0]** and **[#]**, the call is connected to the operator. If the operator is on another call or does not answer, a list of options (Incomplete Call Handling Menu) is announced to guide the caller. The caller can leave a message in the general delivery mailbox or call an extension.

The operator will also be responsible for answering and handling calls that have been transferred.

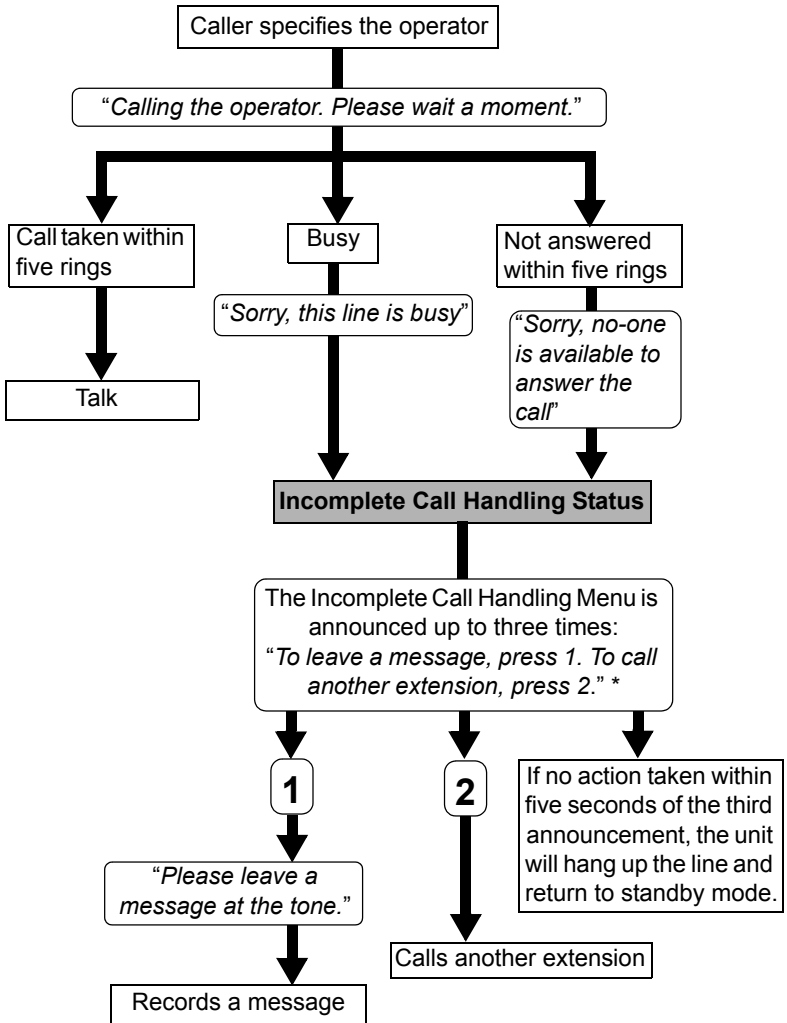

* If the memory is full, the caller cannot leave a message, the caller can only call an extension.

Setting the Answering System **Base Unit**

The Answering System can be set to answer calls with a greeting message. Callers can leave a message in the general delivery mailbox. The Answering System can be assigned to any line.

Ring count: The number of times the unit rings before the Answering System answers a call can be set from “2” to “7” or to “Toll saver”. (The default is 4 rings).

Note:

- When the unit is called remotely from a touch tone phone, if the unit answers on the second ring, there is at least one new message in the general delivery mailbox. If the unit answers on the fourth ring, you have no new messages. Hang up when you hear the third ring. This will save you the toll charge for the call.

Up to five greeting messages of up to two minutes each can be stored. The same messages can be used for the Automated Attendant System (page 67).

If you do not record a greeting message, the following pre-recorded greeting will be used:

“Hello, we are not available now. Please leave your name and phone number after the beep. We will return your call.”

For Voice Mail service subscribers

If you subscribe to a flat-rate service package that includes Caller ID, Call Waiting, Voice Mail, and unlimited local/regional/long distance calls, please note the following:

- To use the Voice Mail service provided by your telephone service provider rather than the unit’s answering system, turn off the answering system (page 73).
- To use this unit’s answering system rather than the Voice Mail service provided by your telephone service

provider, please contact your telephone service provider to deactivate your Voice Mail service.

If your telephone service provider cannot do this:

- Set this unit’s “**Number of rings**” setting so that this unit’s answering system answers calls before the Voice Mail service of your telephone service provider does. It is necessary to check the ring count required to activate the Voice Mail service provided by your telephone service provider before changing this setting.
- Change the ring count of the Voice Mail service so that the answering system can answer the call first. To do so, consult your telephone service provider.

Turning on the Answering System

- 1 Press the line’s **[ANSWER ON]** key.
- 2 Scroll to “**Mailbox**” by pressing **[V]** or **[^]**, then press **[ENTER]**.
 - The current message is played.
 - The **[ANSWER ON]** indicator lights.

Defining the number of rings

- 1 Press the line’s **[ANSWER ON]** key.
- 2 Scroll to “**Setup**” by pressing **[V]** or **[^]**, then press **[ENTER]**.
- 3 Scroll to “**Mailbox**” by pressing **[V]** or **[^]**, then press **[ENTER]**.
- 4 Scroll to “**Number of rings**” by pressing **[V]** or **[^]**, then press **[ENTER]**.
 - The current number of rings is displayed.

Example:

Number of rings	
:2	
AV	ENTER=Set

Answering System

- 5** Set the number of rings by pressing [V] or [^], then press [ENTER].
- The selected number of rings is displayed and confirmation tone is heard.

Selecting the pre-recorded greeting message

- 1** Press the line's [ANSWER ON] key.
- 2** Scroll to "Setup" by pressing [V] or [^], then press [ENTER].
- 3** Scroll to "Mailbox" by pressing [V] or [^], then press [ENTER].
- 4** Scroll to "Select greeting" by pressing [V] or [^], then press [ENTER].
- The current greeting is displayed.

Example:

```
Select greeting
:Prerecord (Eng)
^V          ENTER=Set
```

- 5** Scroll to "Prerecord (Eng)" or "Prerecord (Esp)" by pressing [V] or [^], then press [ENTER].
- The selected pre-recorded message is played.

Recording a greeting message

- 1** Press the line's [ANSWER ON] key.
- 2** Scroll to "Setup" by pressing [V] or [^], then press [ENTER].
- 3** Scroll to "User greetings" by pressing [V] or [^], then press [ENTER].
- 4** Scroll to "Greeting 1" by pressing [V] or [^], then press [ENTER].
- If a message has not been stored, "(none)" is displayed against the greeting.
 - Each time you press [V], the display changes from "Greeting 1" through "Greeting 5".

- 5** Press [▶] to start recording.
- 6** After the tone, talk clearly, about 8 inches (20 cm) away from the microphone (see page 18 for its location). To end, press [1].
- If the elapsed recording time exceeds two minutes, the unit will stop recording.
 - The recorded message will be played.
 - To change the message, press [1] and restart from step 5.
- 7** Press [2] to accept the recorded message.
- Confirmation tone is heard.

Selecting a greeting message

- 1** Press the line's [ANSWER ON] key.
- 2** Scroll to "Setup" by pressing [V] or [^], then press [ENTER].
- 3** Scroll to "Mailbox" by pressing [V] or [^], then press [ENTER].
- 4** Scroll to "Select greeting" by pressing [V] or [^], then press [ENTER].
- 5** Select "Greeting 1" to "Greeting 5" by pressing [V] or [^], then press [ENTER].
- The selected message is played.

Changing a recorded message

- 1** Press the line's [ANSWER ON] key.
- 2** Scroll to "Setup" by pressing [V] or [^], then press [ENTER].
- 3** Scroll to "User greetings" by pressing [V] or [^], then press [ENTER].

4 Select “Greeting 1” to “Greeting 5” by pressing [V] or [^], then press [ENTER].

- The current greeting is played.

5 To accept the message, press [2].

- Confirmation tone is heard.

Or:

To change the message:

Press [1]. Press [▶] to start recording.

After the tone, talk into the microphone.

To end, press [1]. Press [2] to accept the message.

Erasing a greeting message

Whilst listening to the current message, press [CLEAR].

- The greeting is erased.

Turning off the Answering System

Press the line's [ANSWER ON] key and scroll to “OFF”, then press [ENTER].

- The ANSWER ON indicator light goes out.

Guide to programming

For your reference, a chart of all programmable functions is printed below. Details for each item can be found on the corresponding pages.

Important:

- Before programming, ensure that the base unit or cordless handset is not being used. The cordless handset must be operated near the base unit and while off the charger.

Base programming

To program, press **[MENU]**, press **[V]** or **[^]** to scroll through the menu, then press **[ENTER]** when the desired menu item or setting is displayed.

Base unit settings menu	Sub-menu	Sub-menu 2	Page
Add phonebook	–		page 43
Ringer setting	Ringer volume		page 80
	Ringer pattern		page 80
	Ring group		page 82
Date and time	–		page 24
Customer support	–		page 92
Speed dial #	–		page 91
Initial setting	Mailbox	Set password	page 51
		Call monitoring	page 86
		Notify alert	page 86
		Auto message delete	page 88
		Remaining space	page 88
	Caller ID edit	–	page 82
	LCD contrast	–	page 83
	Time adjustment	–	page 90
	Line selection	–	page 84
	Set telephone line	Set line mode	page 25
		Set dial mode	page 25
		Set flash time	page 84
		Call restriction	page 85

Base unit settings menu	Sub-menu	Sub-menu 2	Page
	Initialize base	Clear settings	page 77
		Caller list	page 78
		Phonebook	page 78
		Redial list	page 79
		Messages	page 79
	Registration	HS registration	page 25
		Deregistration	page 27
	Change language	–	page 24
	Music on hold	Music on hold on/off	page 88
		Set music on hold	page 89

Note:

- Press **[EXIT]** at any time to exit programming.
- The unit will return to standby mode if you do not press a key for 60 seconds.

Cordless handset programming

To program, press **[MENU]**, press **[v]** or **[▲]** to scroll through the menu, then press **Select** when the desired menu item or setting is displayed.

Main menu	Sub-menu 1	Sub-menu 2	Page
Add phonebook	–	–	page 43
Ringer setting	Ringer volume	–	page 80
	Ringer pattern	–	page 80
Customer support	–	–	page 92
Speed dial #	–	–	page 91
Initial setting	Mailbox	Message alert	page 86
		Set password	page 52
		Notify alert	page 86
	Caller ID edit	–	page 82
	LCD contrast	–	page 83
	Key tone	–	page 90
	Line selection	–	page 84
	Auto talk	–	page 81
	Initialize HS	Clear settings	page 77
		Caller list	page 78
		Phonebook	page 78
		Redial list	page 79
	Registration	–	page 25
Change HS name	–	page 83	
Change language	–	page 24	

Note:

- Press **[OFF]** at any time to exit programming.
- You can return to the previous display by pressing **[◀]**, except when entering characters or numbers. To return to the main menu from a sub-menu, press **[◀]** or press **Back**.
- The unit will return to standby mode if you do not press a key for 60 seconds.

Initializing base unit and cordless handset(s)

The following features enable you to initialize the base unit and cordless handset(s).

Clearing settings **Base Unit**

Handset

This feature enables you to remove the user-defined settings, and return to the default settings.

Clearing the base unit's settings

The following table lists the default settings for the base unit.

Function	Default setting
Alert number	(Clear)
Alert on/off	OFF
Answering system	OFF
Auto attendant system	OFF
Auto message delete	OFF
Call monitoring	ON
Call restrictions	OFF
Caller ID Edit	ON
Dialing mode	Tone (all lines)
Flash Time	700ms (all lines)
General delivery mailbox password	0000
Language	English
LCD Contrast	Step 3 of 6
Line 1 to 4 greetings	Pre-recorded greeting
Line mode	B mode (all lines)
Line selection	AUTO
Number of rings	4
Ring group	All extensions ring
Ringer pattern	1

Function	Default setting
Ringer volume	HIGH
Speed Dial	(Clear) All Numbers
Time adjustment	CallerID [auto]

- 1 Press **[MENU]**.
- 2 Scroll to "Initial setting" by pressing **[V]** or **[^]**, then press **[ENTER]**.
- 3 Scroll to "Initialize base" by pressing **[V]** or **[^]**, then press **[ENTER]**.
- 4 Scroll to "Clear settings" by pressing **[V]** or **[^]**, then press **[ENTER]**.
 - The "Clear settings?" screen is displayed.
- 5 Press **[CLEAR]**.
 - Confirmation tone is heard.

Clearing the cordless handset's settings

The following table lists the default settings for the cordless handset.

Function	Default settings
Alert number	Clear
Alert on/off	OFF
Answer on/off	OFF
Auto talk	OFF
Caller ID Edit	ON
Direct handset access	ON
Key tone	ON
Language	English
LCD Contrast	Step 3 of 6
Line selection	AUTO
Message alert	ON
Personal mailbox password	1111 to 8888
Ringer pattern	1
Ringer volume	HIGH
Speed Dial	All Number Clear

Programmable Settings

- 1 Press **[MENU]**.
 - 2 Scroll to "Initial setting" by pressing **[▼]** or **[▲]**, then press **Select**.
 - 3 Scroll to "Initialize HS" by pressing **[▼]** or **[▲]**, then press **Select**.
 - 4 Scroll to "Clear settings" by pressing **[▼]** or **[▲]**, then press **Select**.
 - The "Clear settings?" screen is displayed.
 - 5 Press **Yes**.
 - Confirmation tone is heard.
-

Clearing the Caller List

Base Unit Handset

This feature enables you to remove all data from the Caller list.

Clearing the base unit's Caller List

- 1 Press **[MENU]**.
 - 2 Scroll to "Initial setting" by pressing **[▼]** or **[▲]**, then press **[ENTER]**.
 - 3 Scroll to "Initialize base" by pressing **[▼]** or **[▲]**, then press **[ENTER]**.
 - 4 Scroll to "Caller list" by pressing **[▼]** or **[▲]**, then press **[ENTER]**.
 - The "Erase caller list?" screen is displayed.
 - 5 Press **[CLEAR]**.
 - Confirmation tone is heard.
-

Clearing the cordless handset's Caller List

- 1 Press **[MENU]**.
- 2 Scroll to "Initial setting" by pressing **[▼]** or **[▲]**, then press **Select**.
- 3 Scroll to "Initialize HS" by pressing **[▼]** or **[▲]**, then press **Select**.

- 4 Scroll to "Caller list" by pressing **[▼]** or **[▲]**, then press **Select**.
 - The "Erase caller list?" screen is displayed.
 - 5 Press **Yes**.
 - Confirmation tone is heard.
-

Clearing the Phonebook

Base Unit Handset

This feature enables you to remove all data held in the Phonebook. Each Phonebook can only be cleared by the associated cordless handset or base unit.

Clearing the base unit's Phonebook

- 1 Press **[MENU]**.
 - 2 Scroll to "Initial setting" by pressing **[▼]** or **[▲]**, then press **[ENTER]**.
 - 3 Scroll to "Initialize base" by pressing **[▼]** or **[▲]**, then press **[ENTER]**.
 - 4 Scroll to "Phonebook" by pressing **[▼]** or **[▲]**, then press **[ENTER]**.
 - The "Erase phonebook items?" screen is displayed.
 - 5 Press **[CLEAR]**.
 - Confirmation tone is heard.
-

Clearing the cordless handset's Phonebook

- 1 Press **[MENU]**.
 - 2 Scroll to "Initial setting" by pressing **[▼]** or **[▲]**, then press **Select**.
 - 3 Scroll to "Initialize HS" by pressing **[▼]** or **[▲]**, then press **Select**.
 - 4 Scroll to "Phonebook" by pressing **[▼]** or **[▲]**, then press **Select**.
 - The "Erase phonebook items?" screen is displayed.
 - 5 Press **Yes**.
 - Confirmation tone is heard.
-

Clearing the redial list **Base Unit** **Handset**

This feature enables you to remove all held data in the redial list. Each redial list can only be cleared by the cordless handset or base unit associated with it.

Clearing the base unit's redial list

- 1 Press **[MENU]**.
- 2 Scroll to "Initial setting" by pressing **[v]** or **[^]**, then press **[ENTER]**.
- 3 Scroll to "Initialize base" by pressing **[v]** or **[^]**, then press **[ENTER]**.
- 4 Scroll to "Redial list" by pressing **[v]** or **[^]**, then press **[ENTER]**.
 - The "Erase redial list?" screen is displayed.
- 5 Press **[CLEAR]**.
 - Confirmation tone is heard.

Clearing the cordless handset's redial list

- 1 Press **[MENU]**.
- 2 Scroll to "Initial setting" by pressing **[v]** or **[^]**, then press **Select**.
- 3 Scroll to "Initialize HS" by pressing **[v]** or **[^]**, then press **Select**.
- 4 Scroll to "Redial list" by pressing **[v]** or **[^]**, then press **Select**.
 - The "Erase redial list?" screen is displayed.
- 5 Press **Yes**.
 - Confirmation tone is heard.

Erasing messages **Base Unit**

This feature enables you to erase recorded greeting and incoming messages held in the mailboxes.

Note:

- This feature is only available when the mailboxes are not being accessed.

- 1 Press **[MENU]**.
- 2 Scroll to "Initial setting" by pressing **[v]** or **[^]**, then press **[ENTER]**.
- 3 Scroll to "Initialize base" by pressing **[v]** or **[^]**, then press **[ENTER]**.
- 4 Scroll to "Messages" by pressing **[v]** or **[^]**, then press **[ENTER]**.



- 5 Key-in the desired mailbox number using the keypad keys (**[0]** to **[8]**), or **[INTERCOM]** **[1]** to **[8]**.
 - Press **[INTERCOM ALL]** to select all mailboxes, press it again to de-select all mailboxes.
 - Press **[CLEAR]** to erase displayed mailboxes.
- 6 Press **[▶]** to move to the next setting.
- 7 Use **[v]** or **[^]**, to select the option to clear.
 - You can select to erase incoming messages only or both greetings and incoming calls.
- 8 Press **[CLEAR]**.
 - Confirmation tone is heard.

Ringer settings

Selecting the ringer volume

Base Unit Handset

You can set the base unit and cordless handset ringer volumes to **High**, **Medium**, **Low**, or **Ringer Off**. The default setting is **High**.

Note:

- Programming must be carried out separately for the base unit and cordless handset(s).
- Ensure that the base unit/cordless handset is in standby mode.
- If set to off, “**Ringer off**” is displayed while the base unit/cordless handset(s) is in standby mode.
- To turn the ringer off for each line, use the Ring Group feature (page 82).

Setting the base unit’s ringer volume

- 1 Press **[MENU]**.
- 2 Scroll to “**Ringer setting**” by pressing **[v]** or **[^]**, then press **[ENTER]**.
- 3 Scroll to “**Ringer volume**” by pressing **[v]** or **[^]**, then press **[ENTER]**.
 - The current volume is displayed.
- 4 Press **[v]** or **[^]** to select the desired volume.

Example:

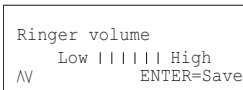

- Each time you press **[v]** or **[^]**, the volume will alter and the chosen volume will sound.
 - To turn the ringer off, press **[v]** repeatedly until “**Ringer off?**” is displayed.
- 5 Press **[ENTER]**.
 - Confirmation tone is heard.

Setting the cordless handset’s ringer volume

- 1 Press **[MENU]**.
- 2 Scroll to “**Ringer setting**” by pressing **[v]** or **[^]**, then press **Select**.
- 3 Scroll to “**Ringer volume**” by pressing **[v]** or **[^]**, then press **Select**.
 - The current volume is displayed.

Example:

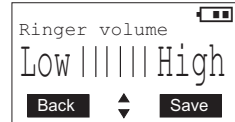

- 4 Press **[v]** or **[^]** to set the volume.
 - Each time you press **[v]** or **[^]**, the volume will alter and the chosen volume will sound.
 - To turn the ringer off, press **[v]** repeatedly until “**Ringer off?**” is displayed.
- 5 Press **Save**.
 - Confirmation tone is heard.

Selecting the ringer pattern

Base Unit Handset

You can select the desired ringer pattern for the base unit and cordless handset(s). Seven patterns are available for each line. The unit and cordless handset are supplied preset to Pattern 1.

Note:

- Programming must be carried out separately for the base unit and cordless handset(s).
- Ensure that the base unit/cordless handset is in standby mode.

Setting the base unit's ringer pattern

- 1 Press **[MENU]**.
- 2 Scroll to "Ringer setting" by pressing **[v]** or **[^]**, then press **[ENTER]**.
- 3 Scroll to "Ringer pattern" by pressing **[v]** or **[^]**, then press **[ENTER]**.
 - The current settings are displayed.

Example:

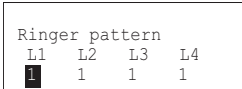

- 4 Press **[◀]** or **[▶]** to select the line to be modified.
- 5 Enter the desired pattern using the keypad (**[1]** to **[7]**), or press **[v]** or **[^]**.
 - Each time you select a pattern, the selected pattern sounds.
- 6 Press **[ENTER]**.
 - Confirmation tone is heard.
 - To move to another line, continue from step 3.

Setting the cordless handset's ringer pattern

- 1 Press **[MENU]**.
- 2 Scroll to "Ringer setting" by pressing **[v]** or **[^]**, then press **Select**.
- 3 Scroll to "Ringer pattern" by pressing **[v]** or **[^]**, then press **Select**.
 - The current settings are displayed.

Example:

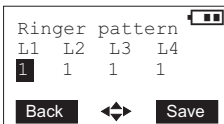

- 4 Press **[◀]** or **[▶]** to select the line to be modified.

- 5 Enter the desired pattern using the keypad (**[1]** to **[7]**), or press **[v]** or **[^]**.
 - Each time you select a pattern, it rings.
 - To move to another line, press **[◀]** or **[▶]**.
- 6 Press **Save**.
 - Confirmation tone is heard.

Call options

Auto talk **Handset**

When this feature is turned on, you can answer a call by lifting the cordless handset off the charger without pressing **[☞]** or **[☜]**. The default setting is OFF.

- 1 Press **[MENU]**.
- 2 Scroll to "Initial setting" by pressing **[v]** or **[^]**, then press **Select**.
- 3 Scroll to "Auto talk" by pressing **[v]** or **[^]**, then press **Select**.
 - The current setting is displayed.
- 4 Press **[v]** or **[^]** to select "On" or "OFF".
- 5 Press **Save**.
 - Confirmation tone is heard.

Note:

- If you subscribe to a Caller ID service and want to view the caller's information on the display after lifting the handset to answer a call, turn this feature off.

Caller ID edit

Handset Base Unit

You can turn the Caller ID number auto edit feature (page 49) on or off. The default setting is ON.

Using the base unit

- 1 Press **[MENU]**.
- 2 Scroll to “**Initial setting**” by pressing **[v]** or **[^]**, then press **[ENTER]**.
- 3 Scroll to “**Caller ID edit**” by pressing **[v]** or **[^]**, then press **[ENTER]**.
- 4 Press **[v]** or **[^]** to select “on” or “off”.
- 5 Press **[ENTER]**.
 - Confirmation tone is heard.

Using the cordless handset

- 1 Press **[MENU]**.
- 2 Scroll to “**Initial setting**” by pressing **[v]** or **[^]**, then press **Select**.
- 3 Scroll to “**Caller ID edit**” by pressing **[v]** or **[^]**, then press **Select**.
- 4 Press **[v]** or **[^]** to select “on” or “off”.
- 5 Press **Save**.
 - Confirmation tone is heard.

Setting up ring groups

Base Unit

This feature allows you to specify which extensions (cordless handsets or base unit) will ring when incoming calls are received on specific lines.

To stop an individual extension (handset or the base unit) ringing for incoming calls on a specific line, remove the handset or base unit from the ring group for that line. The base unit or a handset can make calls using a line even when they have been removed from that line’s ring group.

Note:

- Ensure that the base unit is in standby mode before attempting to set up this feature.

- 1 Press **[MENU]**.
- 2 Scroll to “**Ring setting**” by pressing **[v]** or **[^]**, then press **[ENTER]**.
- 3 Scroll to “**Ring group**” by pressing **[v]** or **[^]**, then press **[ENTER]**.
- 4 Press **[◀]** or **[▶]** to select the line (LINE 1 to 4).
 - The current settings are displayed.
- 5 Press **[v]** to move to “**Ext. #**”.
- 6 Key-in the desired extension number(s), using the keypad keys (**[1]** to **[8]**), or **[INTERCOM]** **[1]** to **[8]**. Enter **[0]** for the base unit.
 - Press **[INTERCOM ALL]** to select all extensions, press it again to de-select all extension numbers.
 - Press **[CLEAR]** to de-select all displayed extension numbers.
- 7 Press **[ENTER]**.
 - Confirmation tone is heard.
 - To program another line, continue from step 3.

Display options

Adjusting the LCD contrast **Handset** **Base Unit**

You can adjust the base unit and cordless handset display contrast. There are six levels; the default setting is level three.

Note:

- Programming must be carried out separately for the base unit and cordless handset(s).

Base unit LCD contrast

- 1 Press **[MENU]**.
- 2 Scroll to “Initial setting” by pressing **[v]** or **[^]**, then press **[ENTER]**.
- 3 Scroll to “LCD contrast” by pressing **[v]** or **[^]**, then press **[ENTER]**.
- 4 Press **[v]** or **[^]** repeatedly to select the desired contrast.
 - The contrast changes with each selection.
- 5 Press **[ENTER]**.
 - Confirmation tone is heard.

Cordless handset LCD contrast

- 1 Press **[MENU]**.
- 2 Scroll to “Initial setting” by pressing **[v]** or **[^]**, then press **Select**.
- 3 Scroll to “LCD contrast” by pressing **[v]** or **[^]**, then press **Select**.
- 4 Press **[v]** or **[^]** repeatedly to select the desired contrast.
 - The contrast changes with each selection.
- 5 Press **Save**.
 - Confirmation tone is heard.

Changing the name of the cordless handset **Handset**

On initial registration, the cordless handset(s) defaults to **Handset 1**, **Handset 2**, etc.

- 1 Press **[MENU]**.
- 2 Scroll to “Initial setting” by pressing **[v]** or **[^]**, then press **Select**.
- 3 Scroll to “Change HS name” by pressing **[v]** or **[^]**, then press **Select**.
 - The cordless handset displays its default name, for example, **Handset 1**, unless modified by another user.
- 4 Enter a name.

Example:



- Press **[◀]** to move the cursor back one character, or press **[▶]** to move the cursor forward one character. Press **[CLEAR]** to erase one character. To clear all characters, press and hold **[CLEAR]** for three seconds.
 - The maximum length of a stored name is 13 characters.
 - To insert a space, press **[0]**.
- 5 Press **Save**.
 - Confirmation tone is heard.

Telephone settings

Selecting the flash time

Base Unit

The flash time depends on your telephone exchange or host PBX.

You can select: “90ms” (milliseconds), “100ms”, “110ms”, “250ms”, “300ms”, “400ms”, “600ms”, or “700ms”.

Each line has its own setting. The default setting for all lines is “700ms”.

- 1 Press **[MENU]**.
- 2 Scroll to “**Initial setting**” by pressing **[V]** or **[^]**, then press **[ENTER]**.
- 3 Scroll to “**Set telephone line**” by pressing **[V]** or **[^]**, then press **[ENTER]**.
- 4 Scroll to “**Set flash time**” by pressing **[V]** or **[^]**, then press **[ENTER]**.
- 5 Press **[◀]** or **[▶]** to select the desired line.
- 6 Press **[V]** or **[^]** repeatedly to select the desired setting, followed by **[ENTER]**.
 - Confirmation tone is heard.

Note:

- The setting should remain at 700 ms unless pressing **[FLASH]** fails to pick up the Call Waiting call.
- If the unit is connected via a PBX, certain PBX functions (call transferring, etc.) may not work correctly. Consult your PBX supplier for the correct setting.

Line selection for outgoing calls

Base Unit Handset

When line selection is set to auto, the cordless handset and base unit automatically selects a line when you press **[☞]** or **[☜]** on the cordless handset, or press **[SP-PHONE]** or lift the handset on the base unit.

The base unit and each handset can also be set to select a priority line for outgoing calls, if available. The line selection for the cordless handset(s) and base unit are set separately. The default is “Auto”.

The five available line selection settings are:

“Auto” (default): When making a call, LINE 1 will be selected, If that line is unavailable, LINE 2 will be selected, etc.

“Line1”: LINE 1 is selected, if available.

“Line2”: LINE 2 is selected, if available.

“Line3”: LINE 3 is selected, if available.

“Line4”: LINE 4 is selected, if available.

Note:

- You can also select a line manually regardless of the line selection mode by pressing a line key.

Base unit line selection

- 1 Press **[MENU]**.
- 2 Scroll to “**Initial setting**” by pressing **[V]** or **[^]**, then press **[ENTER]**.
- 3 Scroll to “**Line selection**” by pressing **[V]** or **[^]**, then press **[ENTER]**.
- 4 Press **[V]** or **[^]** to select the desired line.
- 5 Press **[ENTER]**.
 - Confirmation tone is heard.

Cordless handset line selection

- 1 Press **[MENU]**.
- 2 Scroll to "Initial setting" by pressing **[▼]** or **[▲]**, then press **Select**.
- 3 Scroll to "Line selection" by pressing **[▼]** or **[▲]**, then press **Select**.
- 4 Press **[▼]** or **[▲]** to select the desired line.
- 5 Press **Save**.
 - Confirmation tone is heard.

Setting up the telephone line

Restricting calls **Base Unit**

You can prevent selected phone numbers from being dialed by the base unit and cordless handset(s). Phone numbers with the restricted leading digits cannot be dialed out. You can assign up to eight restricted numbers (up to 11 digits each) to the base unit and cordless handset(s). If a user attempts to dial a restricted number "Call restriction" is displayed.

Note:

- For example, if "123" is set as a restricted number, calls cannot be made to numbers that begin with "123".
- Emergency numbers can be dialed regardless of this feature. The default is set to 911.

To set up call restriction

- 1 While the base unit is in standby mode, press **[MENU]**.
- 2 Scroll to "Initial setting" by pressing **[▼]** or **[▲]**, then press **[ENTER]**.
- 3 Scroll to "Set telephone line" by pressing **[▼]** or **[▲]**, then press **[ENTER]**.
- 4 Scroll to "Call restriction" by pressing **[▼]** or **[▲]**, then press **[ENTER]**.
 - The current settings are displayed, if set.
- 5 Press **[◀]** or **[▶]**, or use the keypad keys (**[1]** to **[8]**), to assign a number between 1 and 8.

Note:

- Up to eight restricted numbers can be stored, and each one is assigned a unique number between 1 and 8.

- 6 Press **[▼]** to select the number.
- 7 Enter the restricted telephone number (up to 11 digits), or leading digits.
 - Press **[CLEAR]** to erase one digit.
 - Press and hold **[CLEAR]** to erase the entire number.
- 8 Press **[▼]** to select "Ext. #:".

Example:

Call restriction:	1
No.:	1211
Ext.#:	1-34----0

- 9 Using the keypad keys or the **[INTERCOM]/[TRANSFER]** key, enter the extension numbers (**[1]** to **[8]**) which cannot dial the restricted number. Enter **[0]** for the base unit.
 - Press **[INTERCOM ALL]** to select all extensions and the base unit.
 - Press **[INTERCOM ALL]** again or **[CLEAR]** to de-select all extensions and the base unit.

Programmable Settings

10 Press **[ENTER]**.

- Confirmation tone is heard.

Example:

```
Call restriction: 1
No.: 111
Ext. #: 12-----80
```

In the above example, phone numbers that start with "111" are restricted for cordless handsets 1, 2, 8 and the base unit.

- To store a second call restriction number, repeat from step 4.
- To return to standby mode, press **[EXIT]**.

Canceling the restricted number

Repeat step 1 through step 6 under "To set up call restriction" on page 85. Press and hold **[CLEAR]**, followed by **[ENTER]**.

Canceling the restricted cordless handset(s) and/or base unit

Repeat step 1 through step 7 under "To set up call restriction" on page 85, then press **[v]** to select "Ext. #:". Enter the base unit and/or cordless handset number(s) by pressing the keypad key(s) (**[0]**, **[1]** to **[8]**), then press **[ENTER]**.

Message alert **Handset**

When a new message enters the mailbox, the cordless handset's antenna flashes notifying you of the message. The default is "ON".

- 1 Press **[MENU]**.
- 2 Scroll to "Initial setting" by pressing **[v]** or **[^]**, then press **Select**.
- 3 Scroll to "Mailbox" by pressing **[v]** or **[^]**, then press **Select**.
- 4 Scroll to "Message alert" by pressing **[v]** or **[^]**, then press **Select**.
 - The current setting is displayed.
- 5 Press **[v]** or **[^]** to select "on" or "off".

6 Press **Save**.

- Confirmation tone is heard.

Call screening (monitoring)

Base Unit

While a caller is recording a message in the general delivery mailbox, you can monitor the call through the base unit's speaker. If more than one line is receiving a call at the same time, only the first one can be monitored. You can answer the call by lifting the handset or by pressing **[SP-PHONE]**.

While monitoring a call, you can temporarily turn the feature OFF by pressing **[MUTE]**. The feature will turn ON again after the call is disconnected.

- 1 While in standby mode, press **[MENU]**.
- 2 Scroll to "Initial setting" by pressing **[v]** or **[^]**, then press **[ENTER]**.
- 3 Scroll to "Mailbox" by pressing **[v]** or **[^]**, then press **[ENTER]**.
- 4 Scroll to "Call monitoring" by pressing **[v]** or **[^]**, then press **[ENTER]**.
 - The current setting is displayed.
- 5 Press **[v]** or **[^]** to select "on" or "off".
- 6 Press **[ENTER]**.
 - Confirmation tone is heard.

Notify alert **Base Unit Handset**

This feature allows the unit to alert a cell phone/paging device when your mailbox has received an incoming message from an outside caller. You can retrieve the message from a touch-tone telephone (page 63). First store a cell phone/paging device number with the base unit or cordless handset(s), then set the unit to call the cell phone/paging device.

The following describes how to set-up the number to be alerted, turn the feature on, and verify that the cell phone/paging device is called.

Note:

- When a message has been transferred or delivered from another user, the unit will not alert your cell phone/paging device.
- Programming must be carried out separately for the base unit and cordless handset(s).

“Alert number”. Defines the alert number.

“Alert on/off”: If a caller leaves a message when set to “On”, the specified alert number (if defined) is called, notifying you that you have a message.

“Calling alert”: Tests that the notify alert function operates correctly.

Using the base unit

- 1 Press **[MENU]**.
- 2 Scroll to “**Initial setting**” by pressing **[V]** or **[^]**, then press **[ENTER]**.
- 3 Scroll to “**Mailbox**” by pressing **[V]** or **[^]**, then press **[ENTER]**.
- 4 Scroll to “**Notify alert**” by pressing **[V]** or **[^]**, then press **[ENTER]**.
- 5 Scroll to “**Alert number**” by pressing **[V]** or **[^]**, then press **[ENTER]**.
 - The current alert number is displayed, if it exists.
- 6 Enter your cell phone/paging device number (maximum of 32 digits), then press **[ENTER]**.
 - Confirmation tone is heard.
- 7 Scroll to “**Alert on/off**” by pressing **[V]** or **[^]**, then press **[ENTER]**.
- 8 To turn on the feature, scroll to “**On**” by pressing **[V]** or **[^]**, then press **[ENTER]**.
 - Confirmation tone is heard.

- 9 Use **Calling alert** to verify that the defined cell phone/paging device rings. Scroll to “**Calling alert #**” by pressing **[V]** or **[^]**, then press **[ENTER]**.

- 10 Press **[SP-PHONE]**.

- The defined cell phone/paging device is called.

Note:

- To display the currently set alert number without changing it, perform steps 1 through 5 above.

Using the cordless handset

- 1 Press **[MENU]**.
- 2 Scroll to “**Initial setting**” by pressing **[V]** or **[^]**, then press **Select**.
- 3 Scroll to “**Mailbox**” by pressing **[V]** or **[^]**, then press **Select**.
- 4 Scroll to “**Notify alert**” by pressing **[V]** or **[^]**, then press **Select**.
- 5 Scroll to “**Alert number**” by pressing **[V]** or **[^]**, then press **Select**.
 - The current alert number is displayed if it exists.
- 6 Enter your cell phone/paging device number (maximum of 32 digits), then press **Save**.
 - Confirmation tone is heard.
- 7 Scroll to “**Alert on/off**” by pressing **[V]** or **[^]**, then press **Select**.
- 8 To turn on the feature, scroll to “**On**” by pressing **[V]** or **[^]**, then press **Save**.
 - Confirmation tone is heard.
- 9 Use **Calling Alert** to verify that the cell phone/paging device rings. Scroll to “**Calling alert #**” by pressing **[V]** or **[^]**, then press **Select**.
- 10 Press **[↶]** or **[⇨]**.
 - The defined cell phone/paging device is called.

Programmable Settings

Note:

- To display the currently set alert number without changing it, perform steps 1 through 5 above.

Automatically deleting messages **Base Unit**

If this feature is set to ON, messages in the mailboxes will automatically be erased after a month. Your phone comes from the factory set to "OFF".

- 1 While in standby mode, press **[MENU]**.
- 2 Scroll to "Initial setting" by pressing **[V]** or **[^]**, then press **[ENTER]**.
- 3 Scroll to "Mailbox" by pressing **[V]** or **[^]**, then press **[ENTER]**.
- 4 Scroll to "Auto message delete" by pressing **[V]** or **[^]**, then press **[ENTER]**.
 - The current setting is displayed if the system's date and time have been set. If the date and time have not been set, you are requested to set them before proceeding.
- 5 Press **[v]** or **[^]** to select "On" or "Off".
- 6 Press **[ENTER]**.
 - Confirmation tone is heard.

Checking the remaining recording time and number of messages **Base Unit**

This feature displays the remaining amount of recording time available, and the number of messages that may be recorded.

- 1 Press **[MENU]**.
- 2 Scroll to "Initial setting" by pressing **[V]** or **[^]**, then press **[ENTER]**.
- 3 Scroll to "Mailbox" by pressing **[V]** or **[^]**, then press **[ENTER]**.

- 4 Scroll to "Remaining space" by pressing **[V]** or **[^]**, then press **[ENTER]**.
 - The current settings are displayed. The display returns to the previous screen after two seconds.

Examples:

```
Remaining space
Time      : 100min
Messages : 100
```

```
Remaining space
Time      : <1min
Messages : 100
```

```
Memory is full
```

Music on hold

Recorded music can be played for callers while they are on hold. You can choose to play the pre-recorded music or record music using the audio cable provided.

Note:

- **U.S. Copyright law (Title 17 U.S.C. Section 101 et seq., Title 18 U.S.C. Section 2319)**
Federal law protects copyright owners from the unauthorized reproduction, adaptation, performance, display or distribution of copyright protected works.
- When choosing music on hold, the copyright implications should be carefully considered. If you are unsure about the legality of using a recording, seek legal advice.

Turning the music on hold feature on or off **Base Unit**

- 1 While in standby mode, press **[MENU]**.
- 2 Scroll to "Initial setting" by pressing **[V]** or **[^]**, then press **[ENTER]**.

3 Scroll to “**Music on hold**” by pressing [V] or [^], then press [ENTER].

4 Scroll to “**Music on hold on/off**” by pressing [V] or [^], then press [ENTER].

- The current setting is displayed.

Example:

```
Music on hold
:On
^V          ENTER=Save
```

5 Select “**on**” or “**off**” by pressing [V] or [^], then press [ENTER].

- The confirmation screen is displayed and confirmation tone is heard.

Example:

```
Music on hold
:On
```

4 Scroll to “**Set music on hold**” by pressing [V] or [^], then press [ENTER].

- The current music on hold is played and the following screen is displayed.

Example:

```
Music on hold check
                                1:02
1=Change                        2=OK
```

5 Press [1] to record new music (or press [2] to accept the current music).

- Music can only be recorded if the current music is not in use. If music is in use, the following screen is displayed:

Example:

```
MOH currently in
use. Please try
again later.
```

- If the current music on hold is not in use, the following screen is displayed:

Example:

```
Music on hold record
                                >=Start
```

6 Press [▶] to begin recording.

- A long beep sounds and recording begins.
- The following screen is displayed:

Example:

```
Music on hold record
                                1:02
                                1=End
```

7 Press [1] to stop recording.

- The new recording is played.

8 Press [1] again to change it, or [2] to accept the new music.

- Confirmation tone is heard.

Recording music on hold

Base Unit

You can record music or a message for callers to hear when they are on hold.

Recording is carried out via the supplied audio cable plugged into the headset socket and the LINE OUT socket of an audio device, such as, a CD player or PC (user supplied).

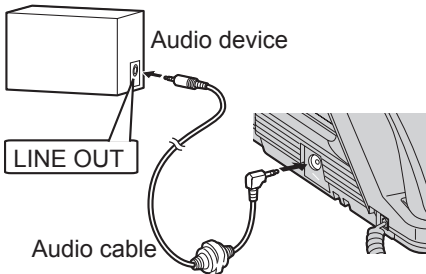

1 While the base unit is in standby mode, press [MENU].

2 Scroll to “**Initial setting**” by pressing [V] or [^], then press [ENTER].

3 Scroll to “**Music on hold**” by pressing [V] or [^], then press [ENTER].

Erasing the current music on hold **Base Unit**

Note:

- You cannot erase the unit's pre-recorded music.
- 1 Follow step 1 through step 4 under "Recording music on hold" on page 89.
 - 2 While the current music on hold is playing, press **[CLEAR]**.
 - The pre-recorded music on hold is set.

Other options

Selecting key tone

Handset

You can select whether key tones are heard when keys are pressed. The default setting is "ON".

- 1 Press **[MENU]**.
- 2 Scroll to "Initial setting" by pressing **[▼]** or **[▲]**, then press **Select**.
- 3 Scroll to "Key tone" by pressing **[▼]** or **[▲]**, then press **Select**.
- 4 Press **[▼]** or **[▲]** to select "On" or "Off".
- 5 Press **Save**.
 - Confirmation tone is heard.

Adjusting the time automatically

Base Unit

This feature specifies whether the system's time and date are adjusted automatically using Caller ID information, or manually when updated by the user.

Note:

- Ensure that the base unit is in standby mode before attempting to set up this feature.

- 1 Press **[MENU]**.
- 2 Scroll to "Initial setting" by pressing **[▼]** or **[▲]**, then press **[ENTER]**.
- 3 Scroll to "Time adjustment" by pressing **[▼]** or **[▲]**, then press **[ENTER]**.
 - The current setting is displayed.
- 4 Press **[▼]** or **[▲]** to select either "CallerID [auto]" (default) or "Manual".
- 5 Press **[ENTER]**.
 - Confirmation tone is heard.

Re-registering a cordless handset with the base unit

Handset

If "No link to the base. Please walk closer to the base and try again." is displayed, even when the cordless handset is near the base unit, you may need to re-register the cordless handset to the base unit.

Important:

- Ensure that the base unit and cordless handset are in standby mode.
- Registration must be completed within one minute.
- The cordless handset cannot be registered if the base unit is not in registration mode.

The procedure for re-registering the cordless handset is the same as the procedure for registration. See page 25.

Storing speed dial numbers

Base Unit Handset

You can store up to 10 speed dial numbers. The base unit and cordless handset(s) speed dial numbers can be set independently of one another. Use the dialing keys ([0] to [9]) to dial the stored numbers.

Note:

- If required, you can include [*], [#], [PAUSE] (page 41) or [FLASH] (page 41) in the speed dial number.

Using the base unit

- 1 Press [MENU].
- 2 Scroll to "Speed dial #" by pressing [v] or [^], then press [ENTER].
- 3 Press [v] or [^] to scroll to the desired speed dial number, then press [ENTER].
- 4 Enter the number using the dialing keys ([0] to [9]).

Example:

```
Speed dial 1
Speed dial 2
Speed dial 3
```

- Press [◀] to move the cursor back one digit.
Press [▶] to move the cursor forward one digit.
Press [CLEAR] to erase the digit to the left of the cursor.
Press and hold [CLEAR] to erase all digits.

Example:

```
0123456789
<> ENTER=Save
```

- 5 Press [ENTER].
 - The speed dial is set.

- 6 To store additional speed dial numbers, repeat steps 3 through 5.

- To erase a speed dial number, press and hold [CLEAR] at step 4, then press [ENTER]. Confirmation tone is heard.

Using the cordless handset

- 1 Press [MENU].
- 2 Scroll to "Speed dial #" by pressing [v] or [^], then press [Select].
- 3 Press [v] or [^] to scroll to the desired speed dial number, then press [Select].
- 4 Enter the number using the dialing keys ([0] to [9]).

Example:

Enter phone no.:
0123456789
Back ◀▶ Save

- Press [◀] to move the cursor back one digit.
Press [▶] to move the cursor forward one digit.
Press [CLEAR] to erase the digit to the left of the cursor.
Press and hold [CLEAR] to erase all digits.

- 5 Press [Save].
 - Confirmation tone is heard.
 - The speed dial is set.

Example:

Speed dial 1:
012-345-6789

- 6 To store additional speed dial numbers, repeat steps 3 through 5.

- To erase a speed dial number, press and hold [CLEAR] at step 4, then press [Save]. Confirmation tone is heard.

Customer support **Base Unit**

Handset

The base unit and cordless handset can display the Internet address where you can obtain help or download operating instructions for this product using your computer.

- 1 Press **[MENU]**.
- 2 If using the handset, scroll to “**Customer support**” by pressing **[▼]** or **[▲]**, then press **Select**.
If using the base unit, scroll to “**Customer support**” by pressing **[v]** or **[^]**, then press **[ENTER]**.
 - “www.panasonic.com/phonehelp” will be displayed.
- 3 If using the handset, press **[OFF]** or **Back**. If using the base unit, press **[EXIT]**.

Programming with direct commands

Most features can be programmed using direct commands. These are codes that allow the configuration of specific features directly, without having to go through the menu process.

Using direct commands on the base unit **Base Unit**

- 1** Press **[MENU]**.
- 2** Press **[⇄]**.
- 3** Enter the feature code from the table below.
 - Refer to the relevant section for a description of the feature and how to access/set-up the feature using the menu.

Feature	Feature code	Page
Add an item to the Phonebook	[1] [0] [1]	page 43
Change the base language	[6] [2] [6]	page 24
Change the ringer pattern	[2] [0] [2]	page 80
Change the ringer volume	[2] [0] [1]	page 80
Check the remaining message space	[6] [0] [8]	page 88
Clear mailbox messages	[6] [2] [2]	page 79
Clear Phonebook items	[6] [2] [0]	page 78
Clear settings	[6] [1] [8]	page 77
Clear the caller list	[6] [1] [9]	page 78
Clear the redial list	[6] [2] [1]	page 79
Deregister handsets	[6] [2] [4]	page 27
Display the customer support screen	[4] [0] [1]	page 92
Edit caller IDs	[6] [0] [9]	page 82
Register a handset	[1] [2] [3]	page 25
Set an alert number	[6] [0] [4]	page 86
Set call restriction options	[6] [1] [7]	page 85
Set caller ID time adjustment	[6] [1] [1]	page 90
Set dial mode (pulse or tone)	[6] [1] [5]	page 25
Set flash time	[6] [1] [6]	page 84
Set LCD contrast	[6] [1] [0]	page 83
Set line mode	[6] [1] [4]	page 25
Set line selection feature	[6] [1] [3]	page 84

Programmable Settings

Feature	Feature code	Page
Set the automatic message delete feature	[6] [0] [7]	page 88
Set the call monitoring feature	[6] [0] [3]	page 86
Set the date and time	[3] [0] [1]	page 24
Set the mailbox password	[6] [0] [2]	page 51
Set up ring groups	[2] [0] [4]	page 82
Speed dial 1	[5] [0] [1]	page 91
Speed dial 10	[5] [1] [0]	page 91
Speed dial 2	[5] [0] [2]	page 91
Speed dial 3	[5] [0] [3]	page 91
Speed dial 4	[5] [0] [4]	page 91
Speed dial 5	[5] [0] [5]	page 91
Speed dial 6	[5] [0] [6]	page 91
Speed dial 7	[5] [0] [7]	page 91
Speed dial 8	[5] [0] [8]	page 91
Speed dial 9	[5] [0] [9]	page 91
Test the alert number (calling alert)	[6] [0] [6]	page 86
Turn music on hold on or off	[6] [2] [7]	page 88
Turn the alert feature on and off	[6] [0] [5]	page 86

Using mailbox direct commands on the base unit **Base Unit**

- 1 Press **[ANSWER ON]** (any line).
- 2 Press **[⇓]**.
- 3 Enter the feature code from the table below.
 - Refer to the relevant section for a description of the feature and how to access/set-up the feature using the menu.

Feature	Feature code	Page
Select a mailbox greeting	[9] [1] [1]	page 72
Select or record a user greeting	[9] [3] [0]	page 67
Set number of rings for the mailbox	[9] [1] [0]	page 71

Using direct commands on the cordless handset **Handset**

- 1** Press **[MENU]**.
- 2** Press **[⇄]**.
- 3** Enter the feature code from the table below.
 - Refer to the relevant section for a description of the feature and how to access/set-up the feature using the menu.

Feature	Feature code	Page
Add an item to the Phonebook	[1] [0] [1]	page 43
Change the cordless handset language	[6] [1] [2]	page 24
Change the handset name	[6] [1] [1]	page 83
Change the ringer pattern	[2] [0] [2]	page 80
Change the ringer volume	[2] [0] [1]	page 80
Clear Phonebook items	[6] [0] [9]	page 78
Clear settings	[6] [0] [7]	page 77
Clear the caller list	[6] [0] [8]	page 78
Clear the redial list	[6] [1] [0]	page 79
Display the customer support screen	[4] [0] [1]	page 92
Edit caller IDs	[6] [0] [2]	page 82
Mailbox menu	[6] [0] [1]	page 51
Register handset	[1] [2] [3]	page 26
Set key tones	[6] [0] [4]	page 90
Set LCD contrast	[6] [0] [3]	page 83
Set line selection feature	[6] [0] [5]	page 84
Set the auto talk feature	[6] [0] [6]	page 81
Speed dial 1	[5] [0] [1]	page 91
Speed dial 2	[5] [0] [2]	page 91
Speed dial 3	[5] [0] [3]	page 91
Speed dial 4	[5] [0] [4]	page 91
Speed dial 5	[5] [0] [5]	page 91
Speed dial 6	[5] [0] [6]	page 91
Speed dial 7	[5] [0] [7]	page 91
Speed dial 8	[5] [0] [8]	page 91
Speed dial 9	[5] [0] [9]	page 91
Speed dial 10	[5] [1] [0]	page 91

Wall mounting the charger

The charger can be wall mounted.

Wall
Template

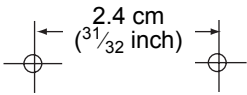

- 1** Using the wall mounting template below, insert two suitably sized screws into the wall.
- 2** Connect the AC adaptor to the charging cradle.
- 3** Slide the charging cradle into place securely on the two screws.

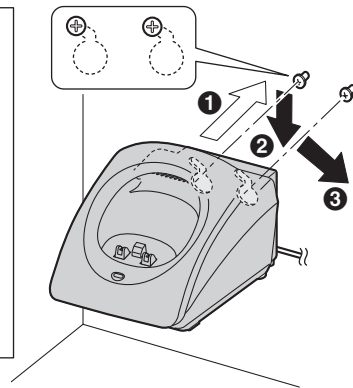
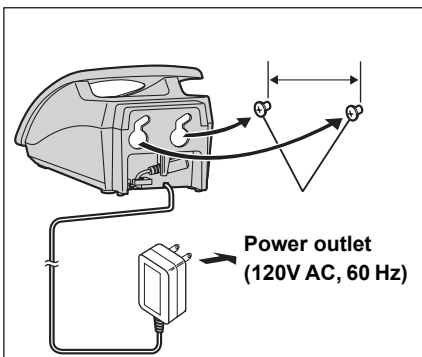

Note:

- When mounting the charger, ensure that the correct screws for the wall are used. Certain types of wall may require plugs to be anchored in the wall before the screws are inserted.
- When mounting the charger, care should be taken to place it so that the cordless handset antenna does not cause a danger when the handset is docked in the charger unit. Particular care should be taken to ensure that the antenna is not mounted at eye level or in a position that may pose a risk to people's eyes.

Cordless handset rechargeable battery replacement

If battery performance diminishes, make sure that you have cleaned the charge contacts and fully charged the battery (page 16). The battery needs to be replaced if any of the following are displayed after a few phone calls, even when you have fully charged the battery:

- “Recharge battery”
- “” (flashing)
- Use only the rechargeable Panasonic battery described on page 5.

- 1 Press down on the cover firmly with your thumb and slide it as indicated by the arrow.

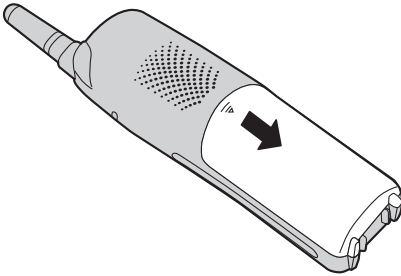

- 2 Replace the old battery with a new one, and close the cover (see page 16 for battery installation).

Note:

- After replacing the battery, place the cordless handset on the charger until confirmation tone sounds or the battery strength prompt displays (page 17).

Backup battery replacement

Even if the backup battery has been fully charged, the BATTERY indicator may flash or the unit may not work within minutes of a power failure. In that case, replace the backup battery with a new Panasonic HHR-P516 battery. See page 5 for ordering information.

Disconnect the telephone line cords, and open the battery cover by pushing down on the tab. Replace the battery, close the battery cover and reconnect the telephone line cords.

Attention:



A nickel metal hydride battery that is recyclable powers the product that you have purchased.

Please call 1-800-8-BATTERY (1-800-822-8837) for information on how to recycle this battery.

Headset (optional)

Connecting an optional headset to the base unit or cordless handset allows hands-free phone conversations. Please use only a Panasonic KX-TCA86 headset.

To connect an optional headset to the base unit

Connect the headset to the headset jack, as shown.

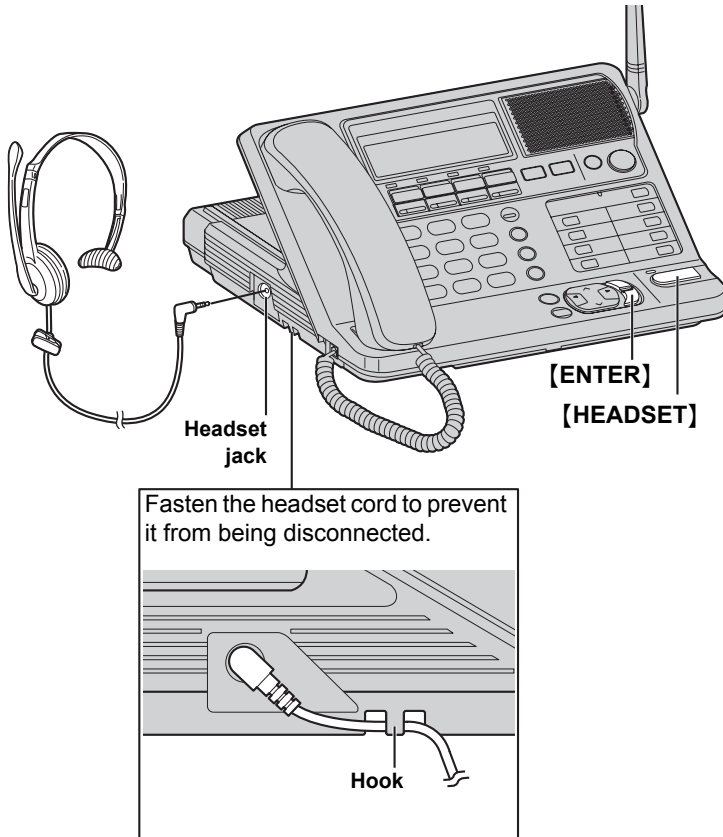

Note:

- To answer an incoming call using the headset, press **[HEADSET]**. To toggle between using the headset and the speakerphone, press **[ENTER]**.
- The SP-PHONE indicator lights when the headset is active.

To connect an optional headset to the cordless handset

Open the headset jack cover, and connect the headset to the headset jack, as shown.



Belt clip

You can hang the cordless handset on your belt or pocket using the included belt clip.

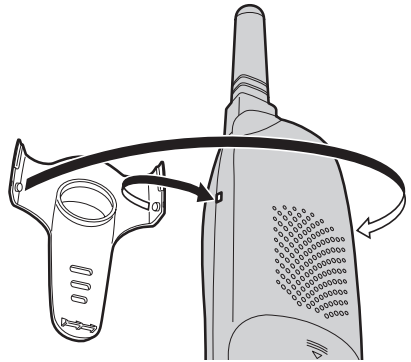

To attach the belt clip



To remove the belt clip



Note:

- To switch to the speakerphone, press . To return to the headset, press .

Reset button

If the unit does not work, press **[RESET]** on the bottom of the base unit with a pointed object.

- After pressing **[RESET]**, the date and time will be erased. Re-adjust the date/time (page 24).

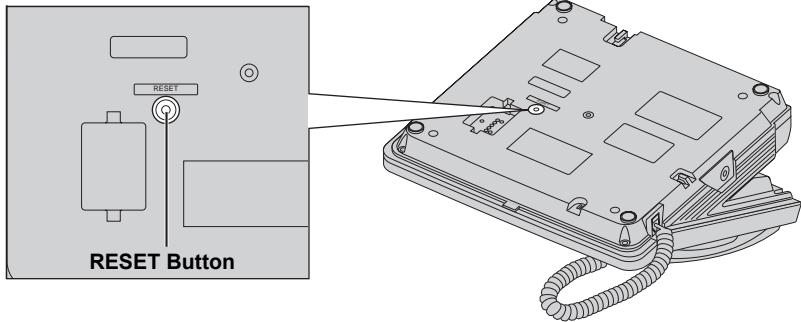

Adding another phone

If the backup battery has been discharged during a power failure, the unit will not work. If required, you can connect a standard telephone on LINE 2 or LINE4 of this unit using a T-adaptor (KX-J66). See page 5 for ordering information.

Example: Connecting a standard telephone on LINE 4.

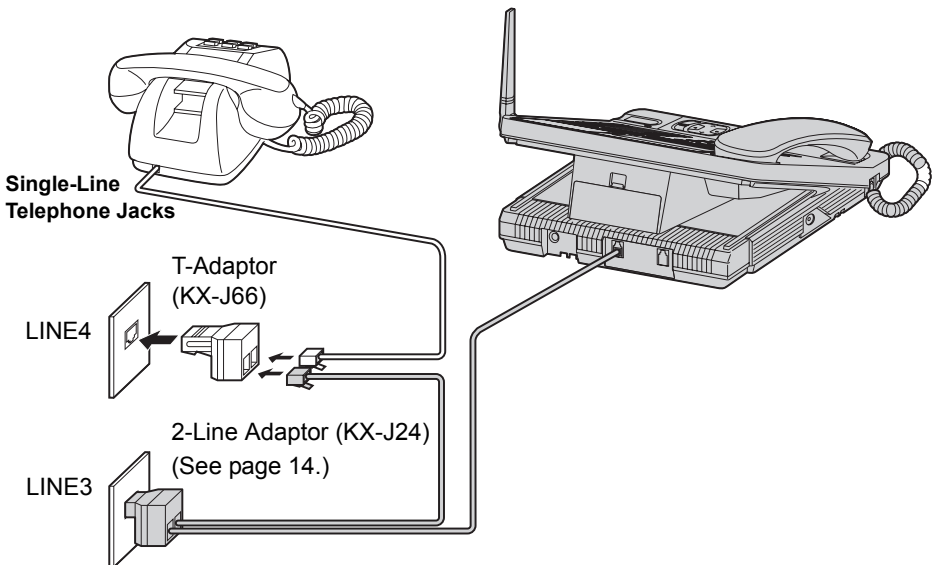

Error messages

Display messages

If the unit detects a problem, one of the following messages will be displayed on the base unit or cordless handset. Error beeps or busy tone are heard.

Display message	Cause and solution
Busy	<ul style="list-style-type: none"> ● The paged party is engaged in a call. ● A paged cordless handset is too far from the base unit.
Call restriction	<ul style="list-style-type: none"> ● The dialed number is restricted. Cancel the restriction (page 86).
Error (base unit only)	<ul style="list-style-type: none"> ● When you tried to register the cordless handset, the cordless handset and base unit could not link for some reason, such as interference from other electrical appliances. Take the cordless handset and base unit away from the electrical appliances and try again. ● Eight cordless handsets have already been registered to the base unit. To cancel another handset registration, see page 27.
Invalid. Please register the handset to the base. (cordless handset only)	<ul style="list-style-type: none"> ● You tried to make a call or access a mailbox with a cordless handset that has not been registered to the base unit. Register the cordless handset (page 25).
Invalid entry	<ul style="list-style-type: none"> ● You tried to key-in an invalid direct command. Key-in the correct command (pages 93 to 95).
Invalid mailbox (base unit only)	<ul style="list-style-type: none"> ● You attempted to deliver/transfer a message to an unregistered cordless handset's mailbox. Register the cordless handset (page 25).
Memory is full	<ul style="list-style-type: none"> ● When trying to store an item in the Phonebook, the Phonebook memory is full. Erase unwanted items and try again (page 46). ● There is no memory available for recording messages. Erase unnecessary messages (page 59).
Message full (base unit only)	<ul style="list-style-type: none"> ● There is no memory available for recording messages. ● Erase unnecessary messages (page 59).
MOH currently in use. Please try again later.	<ul style="list-style-type: none"> ● You tried to record music while the current music on hold is in use (page 89). Try again later.
No handset registered (base unit only)	<ul style="list-style-type: none"> ● No cordless handsets have been registered to the base unit when you attempt to de-register a handset registration (page 27).

Useful Information

Display message	Cause and solution
<p>No link to the base. Please walk closer to the base and try again. (cordless handset only)</p>	<ul style="list-style-type: none"> ● The cordless handset has lost communication with the base unit. Walk closer to the base unit, and try again.
<p>Not Available. Maximum handsets already registered (cordless handset only)</p>	<ul style="list-style-type: none"> ● Eight cordless handsets have already been registered to the base unit. To cancel another cordless handset registration, see page 27.
<p>Please enter another password.</p>	<ul style="list-style-type: none"> ● You selected a password which is the same as another mailbox (page 51). Select another one.
<p>Please lift up and try again. (cordless handset only)</p>	<ul style="list-style-type: none"> ● You attempted to dial from the cordless handset while located in the charger. Lift the handset out of the charger and try again.
<p>Please set the alert number.</p>	<ul style="list-style-type: none"> ● You tried to check the number or set the unit to call the cell phone/paging device without first storing the cell phone/paging device number (page 86).
<p>Please set the system date and time first. (base unit only)</p>	<ul style="list-style-type: none"> ● You must set the date and time before you can program the system to automatically delete messages monthly (page 88).
<p>Recharge Battery (cordless handset only)</p>	<ul style="list-style-type: none"> ● The cordless handset battery needs to be charged. Recharge the battery by placing it on the charger.
<p>Sorry, this mailbox is in use.</p>	<ul style="list-style-type: none"> ● While another user is listening to messages in the general delivery mailbox, you cannot access that mailbox (pages 52 and 56).
<p>The system is busy. Please try again later.</p>	<ul style="list-style-type: none"> ● All lines are in use. You cannot make a call. Try again later. <p>If four cordless handsets or the base unit and three other cordless handsets are in use:</p> <ul style="list-style-type: none"> ● you may not be able to program certain function items, such as, setting your password or turning on/off alerting your cell phone/paging device, ● you may not be able to make an external or internal call, or ● you may not be able to listen to messages in your mailbox. <p>Try again later.</p>
<p>Users in mailbox. Please try again later.</p>	<ul style="list-style-type: none"> ● You tried to erase mailbox messages while the selected mailbox(es) is being accessed (page 79). Try again later.

Voice messages

If the unit detects a problem, one of the following messages will be announced.

Voice message	Cause and solution
<i>"Sorry, there is no space for recording"</i>	<ul style="list-style-type: none"> ● The remaining recording time or the number of messages which can still be recorded is 0. Erase unnecessary messages (pages 54, 59 and 79).
<i>"Incorrect entry"</i>	<ul style="list-style-type: none"> ● An invalid extension number was entered when transferring or delivering a message. Ensure that the cordless handset is registered to the base unit (page 25).
<i>"This is your mailbox"</i>	<ul style="list-style-type: none"> ● You entered your own mailbox number when transferring a message (page 54).
<i>"Sorry, this mailbox is in use"</i>	<ul style="list-style-type: none"> ● You tried to access the general delivery mailbox from the cordless handset or access a personal mailbox from the base unit while another user was listening to messages there (page 64).

Troubleshooting

General use

Problem	Cause and solution
The unit does not work.	<ul style="list-style-type: none">● Check the settings (pages 74, 76 and 77).● Press [RESET] on the bottom of the base unit with a pointed object (page 100).
The cordless handset does not work.	<ul style="list-style-type: none">● Charge the battery fully (page 16).● Clean the charge contacts and charge again (pages 16 and 21).● Install the battery properly (page 16).● Re-install the battery and place the cordless handset on the charger (page 16). Try again.● The cordless handset has not been registered to the base unit. Register the cordless handset (page 25).● After inserting the battery, press [OFF].
The cordless handset display shows “No link to the base. Please walk closer to the base and try again”.	<ul style="list-style-type: none">● The cordless handset has lost communication with the base unit. Move closer to the base unit, and try again.● Raise the base unit antenna.● If the above remedies do not solve the problem, the cordless handset may have lost communication with the base unit. Register the cordless handset again (page 25).
The line indicators do not work properly.	<ul style="list-style-type: none">● Check the settings (pages 74, 76 and 77).● The line mode selection is incorrect (page 25).
You cannot have a conversation using the headset.	<ul style="list-style-type: none">● Make sure that the headset is properly plugged into the headset jack on the cordless handset (page 99) or base unit (page 98).
I cannot register a cordless handset to the base unit.	<ul style="list-style-type: none">● Fully charge the battery (page 16).● A cordless handset cannot be registered if there are already eight registered cordless handsets.
I cannot have a conversation using the cordless handset when the headset is connected.	<ul style="list-style-type: none">● When the headset is connected (page 99) to the cordless handset, you must use the headset to talk with the caller. To have a normal conversation, disconnect the headset.

Programmable settings

Problem	Cause and solution
I cannot program function items, such as the dialing mode.	<ul style="list-style-type: none"> ● Programming is not possible while the base handset is off the cradle or the [SP-PHONE] indicator lights. ● Programming is not possible while in talk or intercom mode, or while listening to the messages. ● Do not pause for over 60 seconds while programming. ● Make sure that the cordless handset is in standby mode.
While programming, the unit/cordless handset starts to ring.	<ul style="list-style-type: none"> ● A call is being received. Answer the call and re-start programming from the beginning after hanging up.
I can't access the cordless handset function menu.	<ul style="list-style-type: none"> ● Access is not possible during a call, or while accessing a mailbox, the Caller List, or the Phonebook.

Making/answering calls, paging

Problem	Cause and solution
Static is heard, sound cuts in/out. Interference from other electrical units.	<ul style="list-style-type: none"> ● Move the cordless handset(s) and the base unit away from other electrical appliances (page 9). ● Move closer to the base unit. ● Raise the base unit antenna. ● If your unit is connected to a telephone line with DSL service, we recommend connecting a noise filter between the base unit and the telephone line jack. Contact your DSL provider for details.
The unit/cordless handset does not ring.	<ul style="list-style-type: none"> ● The ringer volume is set to OFF. Select HIGH, MEDIUM, or LOW (page 80). ● If four cordless handsets are in use, the unit may not ring. The cordless handset users will hear incoming call tone. ● The base unit/cordless handset is removed from the ring group. Add to the ring group (page 82). ● All lines have been set-up to be answered by the automated attendant (page 66).
I cannot make a call.	<ul style="list-style-type: none"> ● The dialing mode may be set incorrectly. Set the dial mode (page 25) to match the type of telephone service you have (tone or pulse). ● The dialed number is restricted (page 85).

Useful Information

Problem	Cause and solution
I cannot redial the last number dialed.	<ul style="list-style-type: none">● If the last number dialed was more than 32 digits, the number will not be redialed correctly.● Access numbers entered after pressing [TONE] will not be included when redialing.● Cordless handset only: The [REDIAL] key also functions as the [PAUSE] key. It will redial the last number dialed if pressed at the outset of a call. If another number has been dialed first, it will operate as a [PAUSE] key.
I cannot page another cordless handset or the base unit.	<ul style="list-style-type: none">● If four other cordless handsets are in use, you may not be able to page. Try again later.● The cordless handset is too far from the base unit.● The base unit or the cordless handset is in use. Try again later.
When a second call is received on the same line, the unit does not display the new caller's information.	<ul style="list-style-type: none">● If another call is received on the same line while;<ul style="list-style-type: none">– the Automated Attendant System or Answering System is responding to a call, or– a call is placed on hold, the caller information will not be displayed.● The line mode selection is incorrect. See page 25.

Phonebook

Problem	Cause and solution
I cannot store a name and phone number in the Phonebook.	<ul style="list-style-type: none">● You cannot store an item in the Phonebook while the corded handset is off the cradle or the [SP-PHONE] indicator is lit.● You cannot store an item in the Phonebook while the unit is in talk or intercom mode.● Do not pause for over 60 seconds while programming.
The display goes into standby mode while viewing the Phonebook.	<ul style="list-style-type: none">● Do not pause for over 60 seconds while searching.
While searching, the base unit/cordless handset starts to ring.	<ul style="list-style-type: none">● A call is being received. Answer the call and re-start searching from the beginning after hanging up.

Caller ID

Problem	Cause and solution
The caller's information is not displayed.	<ul style="list-style-type: none"> ● You have not subscribed to a caller ID service. Contact your telephone service provider to subscribe. ● If your unit is connected to any additional telephone equipment such as a caller ID box or wireless telephone jack, disconnect the unit from the equipment and plug the unit directly into the wall jack. ● If your unit is connected to a telephone line with DSL service, we recommend connecting a noise filter between the base unit and the telephone line jack. Contact your DSL provider for details. ● The name display service may not be available in some areas. Contact your telephone service provider for details. ● Other telephone equipment may be interfering with this unit. Disconnect the other equipment and try again. ● The caller requested not to send caller information (page 47). ● Generally caller information is displayed after the second ring.
The display goes into standby mode while viewing the Caller List.	<ul style="list-style-type: none"> ● Do not pause for over 60 seconds while searching.
The caller list/incoming phone numbers are not edited automatically.	<ul style="list-style-type: none"> ● The Caller ID number auto edit feature is turned off. Turn it on and try again (page 49). ● You need to call back the edited number to activate Caller ID number auto edit.
The second caller's information is not displayed during an outside call. (The Call Waiting Caller ID (CWID) feature does not function.)	<ul style="list-style-type: none"> ● In order to use Caller ID, Call Waiting, or Call Waiting Caller ID (CWID), you must first contact your telephone service provider and subscribe to the desired service. After subscribing, you may need to contact your telephone service provider again to activate this specific service, even if you already subscribed to both Caller ID and Call Waiting with Caller ID services (CWID).

Recharging the battery (cordless handset)

Problem	Cause and solution
"Recharge battery" is displayed, "■" flashes and the cordless handset beeps every 60 seconds.	<ul style="list-style-type: none">● Fully charge the battery (page 16).
I charged the battery fully, but "Recharge battery" is still displayed and "■" continues to flash.	<ul style="list-style-type: none">● Clean the charge contacts and charge again.● The battery may need to be replaced (page 97). If you install a new battery, fully charge it (page 16).
The CHARGE indicator light does not go out after the battery has been charged.	<ul style="list-style-type: none">● This is normal.
The cordless handset display is blank.	<ul style="list-style-type: none">● Confirm that the battery is properly installed (page 16).● Fully charge the battery (page 16).

Voice mail system/automated attendant system/answering system

Problem	Cause and Solution
The Automated Attendant System or Answering System is on, but incoming messages are not recorded.	<ul style="list-style-type: none"> ● The remaining recording time or the number of messages which can still be recorded is 0. Erase unnecessary messages (pages 54, 59 and 79).
“ Message full ” is displayed on the base unit, and no new messages are recorded.	<ul style="list-style-type: none"> ● The remaining recording time or the number of messages which can still be recorded is 0. Erase unnecessary messages (page 59).
I cannot access my mailbox by pressing ☒ on the base unit, or M.box on the cordless handset.	<ul style="list-style-type: none"> ● Make sure that the base unit/cordless handset is in standby mode. ● If four cordless handsets or the base unit and three cordless handsets are in use, you cannot access the mailbox. Try again later. ● If the Automated Attendant System or Answering System is responding to four calls on separate lines, you cannot access the mailbox. Try again later. ● You are too far from the base unit. Walk closer to the base unit. ● If “Enter mailbox password” is displayed, the direct handset access mode is OFF. Enter the mailbox password and press Next.
I cannot access a mailbox from a touch tone phone.	<ul style="list-style-type: none"> ● The Automated Attendant System or Answering System may not respond if the tones are too short to activate the unit. Press each key firmly.
While recording a greeting message, the unit starts to ring and stops recording.	<ul style="list-style-type: none"> ● To answer the call, press the called line key. The recording will stop. Start from the beginning after hanging up.
During playback, incoming call tone is heard.	<ul style="list-style-type: none"> ● To answer the call, press the called line key. To resume playback, press “☒” after hanging up.
The display does not show the name and/or number of the caller whose message is being played.	<ul style="list-style-type: none"> ● If the caller’s name is not stored in the Caller List, the caller’s information will not be displayed.
The unit does not alert your cell phone/paging device.	<ul style="list-style-type: none"> ● The number has been entered incorrectly. ● Line 1 was busy and the call to the alert number could not be made. ● After three failed attempts to alert a cell phone/paging device, the unit gives up.

Frequently asked questions

The base unit

Problem	Cause and solution
The base phone has a dial tone but none of the keys are working. It has worked before; is the base broken?	<ul style="list-style-type: none">● Ensure that the memory card and memory card cover are not pressing down any of the intercom/transfer keys. See page 19 for details on how to install the memory card.
Backup battery: How long will the base unit retain its memory after a power failure?	<ul style="list-style-type: none">● The rechargeable NiMH backup battery will maintain all functions of the base unit for a minimum of 20 minutes in the event of a mains power failure. See page 11 for more information about the backup battery.● If the backup battery becomes exhausted during a long power outage, messages stored in the base unit's memory are maintained indefinitely in flash memory.
Call monitoring: How can I disable the call monitoring feature to prevent others from hearing my incoming calls?	<ul style="list-style-type: none">● You can temporarily disable the call monitoring feature by pressing [MUTE].● The call monitoring service can also be programmed to remain off, if necessary. See page 86.
Resetting the base unit: My base unit has stopped working, cordless handsets cannot link to it, and new cordless handsets cannot be registered. How can I reset the base unit?	<ul style="list-style-type: none">● If the base unit becomes locked and stops working, you may need to press the [RESET] button to resolve the problem. The [RESET] key is located on the underside of the base unit and must be pressed with a pointed object. See page 100.

The cordless handset

Problem	Cause and solution
Resetting the cordless handset: My cordless handset has stopped ringing and there is interference. How can I reset the cordless handset?	<ul style="list-style-type: none">● When the cordless handset stops ringing and interference is heard, you can remove the battery for at least 30 seconds and then replace it to reset the device. See page 16.

Messages and voice mail

Problem	Cause and solution
Remote message retrieval: How can I retrieve voice mail messages from other locations?	<ul style="list-style-type: none"> ● Voice messages can be retrieved while away from home or office using a touch tone phone if the automated attendant system or auto answer system is active for any of the lines. To access messages remotely: <ul style="list-style-type: none"> – Dial the main phone number. The unit will be in either Automated Attendant mode or Auto Answer mode. ● The password for handset 1 is “1111” by default. See page 63 for a full explanation of available commands.
Incoming messages: What is the maximum message length a caller can leave?	<ul style="list-style-type: none"> ● The maximum message length is three minutes. Up to 255 messages can be left in total, including all cordless handsets, the base unit, and greeting messages.
Transferring calls to voice mail: How can I transfer a call to another person's voicemail?	<ul style="list-style-type: none"> ● A call can only be transferred directly to the General Delivery Mailbox, not to other extensions. You can however transfer a call to another person's voice mail through the General Delivery Mailbox. ● When a call is received at the base unit, the operator must press the  key and replace the base unit handset. The caller will then hear the greeting assigned to the line on which he is calling. While the greeting is playing, the caller can press the extension number followed by [#]. ● If the cordless handset answer mode is on, the caller will hear the personal greeting message at the end of the second ring, then he/she can leave a message at the tone. ● If the cordless handset answer mode is off, the caller will hear the following message at the end of the fifth ring: <i>“Sorry, no one is available to answer the call. To leave a message, press 1. To call another extension, press 2. To call the operator, press 0”</i>. If the person the caller wishes to speak to is on another call, the caller will hear <i>“Sorry, this line is busy. To leave a message, press 1. To call another extension, press 2. To call the operator, press 0”</i>.
No beep after greeting message: The greeting message is played but there is no beep, what is wrong?	<ul style="list-style-type: none"> ● This happens when the particular line is set to Automated Attendant mode. It should be set to Auto Answer mode. See page 71.

Calls

Problem	Cause and solution
Phones do not ring and the greeting is repeated three times: None of the phones ring when incoming calls are received and the greeting is played three times, what is wrong?	<ul style="list-style-type: none">• When the automated attendant is on, there is no ring and the caller must select an extension followed by [#]. If no extension is selected, or the caller does not have a touch tone phone, the greeting will repeat three times. In Auto Answer mode, all phones ring until the greeting message is played. After the greeting message there is a beep and the caller can leave a message in the general mailbox.
“ Missed call (s) ” displayed on cordless handset or base unit: What does it mean when the message “ Missed call (s) ” appears on the cordless handset or base unit displays?	<ul style="list-style-type: none">• This message appears when new call information is added to the Caller List. Caller ID information is added to the Caller List automatically when calls are received. The message can be cleared by pressing the [▼] or [▲] keys.

Lines

Problem	Cause and solution
Line indicator lights: Why is the Line Indicator light on when the line is not in use?	<ul style="list-style-type: none">• This could possibly be the result of a connection problem. Make sure that your lines are connected properly, see page 13.
Can't select lines when other lines are occupied: Why can't I select a line when other lines are occupied? Is this system compatible with a roll over line?	<ul style="list-style-type: none">• Yes, this product is compatible with roll over lines. You may need to reset the base unit. The [RESET] button is located on the underside of the base unit and must be pressed with a pointed object. See page 100.

FCC and other information

This equipment complies with Part 68 of the FCC rules and the requirements adopted by the ACTA. On the bottom of this equipment is a label that contains, among other information, a product identifier in the format US:ACJ-----.

If requested, this number must be provided to the telephone company.

- Registration No
.....(found on the bottom of the unit)
- Ringer Equivalence No.
(REN).....0.6B
- Facility Interface Code
.....02LS2
- Service Order Code
.....9.0F
- Required Network Interface Jack
.....RJ11, RJ14

A plug and jack used to connect this equipment to the premises wiring and telephone network must comply with the applicable FCC Part 68 rules and requirements adopted by the ACTA. A compliant telephone cord and modular plug is provided with this product. It is designed to be connected to a compatible modular jack that is also compliant.

The REN is used to determine the number of devices that may be connected to a telephone line. Excessive RENs on a telephone line may result in the devices not ringing in response to an incoming call. In most but not all areas, the sum of RENs should not exceed five (5.0). To be certain of the number of devices that may be connected to a line, as determined by the total RENs, contact the local telephone company. For products approved after July 23, 2001, the REN for this product is part of the product identifier that has the format US:AAAEQ##TXXXX. The digits represented by ## are the REN without a decimal point (e.g., 06 is a REN of 0.6).

If this equipment causes harm to the telephone network, the telephone company will notify you in advance that temporary discontinuance of service may be required. But if advance notice isn't practical, the telephone company will notify the customer as soon as possible. Also, you will be advised of your right to file a complaint with the FCC if you believe it is necessary.

The telephone company may make changes in its facilities, equipment, operations or procedures that could affect the operation of the equipment. If this happens the telephone company will provide advance notice in order for you to make necessary modifications to maintain uninterrupted service.

If trouble is experienced with this equipment, for repair or warranty information, please contact a Factory Servicenter or other Authorized Servicer. If the equipment is causing harm to the telephone network, the telephone company may request that you disconnect the equipment until the problem is resolved.

Connection to party line service is subject to state tariffs. Contact the state public utility commission, public service commission or corporation commission for information.

If your home has specially wired alarm equipment connected to the telephone line, ensure the installation of this equipment does not disable your alarm equipment. If you have questions about what will disable alarm equipment, consult your telephone company or a qualified installer.

This equipment is hearing aid compatible as defined by the FCC in 47 CFR Section 68.316.

Useful Information

When you hold the phone to your ear, noise might be heard in your Hearing Aid. Some Hearing Aids are not adequately shielded from external RF (radio frequency) energy. If noise occurs, use an optional headset accessory or the speakerphone option (if applicable) when using this phone. Consult with your audiologist or Hearing Aid manufacturer about the availability of Hearing Aids which provide adequate shielding to RF energy commonly emitted by digital devices.

WHEN PROGRAMMING EMERGENCY NUMBERS AND/OR MAKING TEST CALLS TO EMERGENCY NUMBERS:

- 1) Remain on the line and briefly explain to the dispatcher the reason for the call.
- 2) Perform such activities in the off-peak hours, such as early morning or late evenings.

This device complies with Part 15 of the FCC Rules. Operation is subject to the following two conditions:

(1) This device may not cause harmful interference, and (2) this device must accept any interference received, including interference that may cause undesired operation.

Privacy of communications may not be ensured when using this phone.

CAUTION:

Any changes or modifications not expressly approved by the party responsible for compliance could void the user's authority to operate this device.

NOTE:

This equipment has been tested and found to comply with the limits for a Class B digital device, pursuant to Part 15 of the FCC Rules. These limits are designed to provide reasonable protection against harmful interference in a residential installation. This equipment generates, uses, and can radiate radio frequency energy and, if not installed and used in accordance with the instructions, may cause harmful interference to radio communications. However, there is no guarantee that interference will not occur in a particular installation. If this equipment does cause harmful interference to radio or television reception, which can be determined by turning the equipment off and on, the user is encouraged to try to correct the interference by one or more of the following measures:

- Reorient or relocate the receiving antenna.
- Increase the separation between the equipment and receiver.
- Connect the equipment into an outlet on a circuit different from that to which the receiver is connected.
- Consult the dealer or an experienced radio/TV technician for help.

Some cordless telephones operate at frequencies that may cause interference to nearby TVs and VCRs. To minimize or prevent such interference, the base of the cordless telephone should not be placed near or on top of a TV or VCR. If interference is experienced, move the cordless telephone further away from the TV or VCR. This will often reduce, or eliminate, interference.

FCC RF Exposure Warning:

This product complies with FCC radiation exposure limits set forth for an uncontrolled environment. To comply with FCC RF exposure requirements the base unit must be installed and operated with its antenna located 20 cm or more between antenna and all person's body (excluding extremities of hands, wrist and feet). The handset unit may be carried and operated with only the specific provided belt-clip. Other non-tested belt-clips or similar body-worn accessories may not comply and must be avoided. The base and handset units must not be co-located or operated in conjunction with any other antenna or transmitter.

Specifications

General	
Operating environment	5 °C - 40 °C (41 °F - 104 °F)
Frequency	5.76 GHz - 5.84 GHz

Base unit	
Dimensions	Approx: 125 mm (height) x 270 mm (width) x 240 mm (depth) (4.92 inch x 10.63 inch x 9.45 inch)
Mass (weight)	Approx: 1.5kg (3.3 lbs)
Power consumption	Approx: Standby: 2.4W Maximum: 5.4W
Power supply	AC adaptor (120 V AC, 60Hz)
Backup battery	HHR-P516 6V 1100 mAh
Backup battery charge time	16 hours
Backup function	When fully charged, backup battery will provide at least 20 minutes use if power fails.

Cordless Handset	
Dimensions	Approx: 220 mm (height) x 40 mm (width) x 55 mm (depth) (8.66 inch x 1.57 inch x 2.16 inch)
Mass (weight)	Approx: 190g (0.42 lb)
Power output	250 mW (max.)
Power supply	Ni-MH battery (3.6 V, 830 mAh)
Talk and standby time	Up to 15 hours talk time ^a or 7 days standby
Charging time	7 hours

a. Maximum talk time achieved after several recharge cycles.

Charger (KX-TGA450 only)	
Dimensions	Approx: 71 mm (height) x 72 mm (width) x 100 mm (depth) (2.80 inch x 2.83 inch x 3.94 inch)
Mass (weight)	Approx: 117g (0.26 lb)
Power consumption	Standby: Approx. 0.8W Maximum: Approx. 4.0W
Power supply	AC adaptor (120 V AC, 60Hz)

- Design and specifications are subject to change without notice.
- The illustrations in these instructions may vary slightly from the actual product.

Warranty

PANASONIC CONSUMER
ELECTRONICS COMPANY, DIVISION
OF PANASONIC CORPORATION OF
NORTH AMERICA
One Panasonic Way,
Secaucus, New Jersey 07094

PANASONIC PUERTO RICO, INC.
San Gabriel Industrial Park,
Ave. 65 de Infantería, Km. 9.5,
Carolina, Puerto Rico 00985

Panasonic Telephone Products Limited Warranty

Limited Warranty Coverage

If your product does not work properly because of a defect in materials or workmanship, Panasonic Consumer Electronics Company or Panasonic Puerto Rico, Inc. (collectively referred to as "the warrantor") will, for the length of the period indicated on the chart below, which starts with the date of original purchase ("Limited Warranty period"), at its option either (a) repair your product with new or refurbished parts, or (b) replace it with a new or a refurbished product. The decision to repair or replace will be made by the warrantor.

Parts

One (1) Year

Labor

One (1) Year

During the "Labor" Limited Warranty period there will be no charge for labor. During the "Parts" Limited Warranty period, there will be no charge for parts. You must mail-in your product prepaid during the Limited Warranty period. This Limited Warranty excludes both parts and labor for batteries, antennas, and cosmetic parts (cabinet). This Limited Warranty only applies to products purchased and serviced in the United States or Puerto Rico. This Limited Warranty is extended only to the original purchaser and only covers products purchased as new.

Mail-In Service

For assistance in the continental U.S.A. in obtaining repairs please ship the product prepaid to:

Panasonic Services Company Customer Servicenter

4900 George McVay Drive Suite B Door #12 McAllen, TX 78503

For assistance in Puerto Rico call Panasonic Puerto Rico, Inc. (787)-750-4300 or fax (787)-768-2910.

When shipping the unit carefully pack, include all accessories, and send it prepaid, adequately insured and preferably in the original carton. Include a letter detailing the complaint and provide a day time phone number where you can be reached.

IF REPAIR IS NEEDED DURING THE LIMITED WARRANTY PERIOD THE PURCHASER WILL BE REQUIRED TO FURNISH A SALES RECEIPT/PROOF OF PURCHASE INDICATING DATE OF PURCHASE, AMOUNT PAID AND PLACE OF PURCHASE. CUSTOMER WILL BE CHARGED FOR THE REPAIR OF ANY UNIT RECEIVED WITHOUT SUCH PROOF OF PURCHASE.

Limited Warranty Limits And Exclusions

This Limited Warranty ONLY COVERS failures due to defects in materials or workmanship, and DOES NOT COVER normal wear and tear or cosmetic damage. The Limited Warranty ALSO DOES NOT COVER damages which occurred in shipment, or failures which are caused by products not supplied by the warrantor, or failures which result from accidents, misuse, abuse, neglect, bug infestation, mishandling, misapplication, alteration, faulty installation, set-up adjustments, misadjustment of consumer controls, improper maintenance, power line surge, lightning damage, modification, introduction of sand, humidity or liquids, or rental use of the product, or service by anyone other than a Factory Servicenter or other Authorized Servicer, or damage that is attributable to acts of God.

THERE ARE NO EXPRESS WARRANTIES EXCEPT AS LISTED UNDER "LIMITED WARRANTY COVERAGE". THE WARRANTOR IS NOT LIABLE FOR INCIDENTAL OR CONSEQUENTIAL DAMAGES RESULTING FROM THE USE OF THIS PRODUCT, OR ARISING OUT OF ANY BREACH OF THIS LIMITED WARRANTY. (As examples, this excludes damages for lost time, lost calls or messages, cost of having someone remove or re-install an installed unit if applicable, travel to and from the servicer. The items listed are not exclusive, but are for illustration only.) **ALL EXPRESS AND IMPLIED WARRANTIES, INCLUDING THE WARRANTY OF MERCHANTABILITY, ARE LIMITED TO THE PERIOD OF THE LIMITED WARRANTY.**

Some states do not allow the exclusion or limitation of incidental or consequential damages, or limitations on how long an implied warranty lasts, so the exclusions may not apply to you.

This Limited Warranty gives you specific legal rights and you may also have other rights which vary from state to state. If a problem with this product develops during or after the Limited Warranty period, you may contact your dealer or Servicenter. If the problem is not handled to your satisfaction, then write to the warrantor's Consumer Affairs Department at the addresses listed for the warrantor.

PARTS AND SERVICE, WHICH ARE NOT COVERED BY THIS LIMITED WARRANTY, ARE YOUR RESPONSIBILITY.

Customer services

Customer Services Directory

Obtain Product Information and Operating Assistance; locate your nearest Dealer or Servicenter; purchase Parts and Accessories; or make Customer Service and Literature requests by visiting our Web Site at:

<http://www.panasonic.com/phonehelp>

or, contact us via the web at:

<http://www.panasonic.com/contactinfo>

You may also contact us directly at: 1-800-211-PANA (1-800-211-7262), Monday-Friday 9 am-9 pm; Saturday-Sunday 10 am-7 pm, EST.

TTY users (hearing or speech impaired users) can call 1-877-833-8855.

Accessory Purchases

Purchase Parts, Accessories and Instruction Books online for all Panasonic Products by visiting our Web Site at:

<http://www.pasc.panasonic.com>

or, send your request by E-mail to:

npcparts@us.panasonic.com

You may also contact us directly at:

1-800-332-5368 (Phone) 1-800-237-9080 (Fax Only)

(Monday - Friday 9 am to 9 pm, EST.)

Panasonic Services Company

20421 84th Avenue South, Kent, WA 98032

(We Accept Visa, MasterCard, Discover Card, American Express, and Personal Checks)

TTY users (hearing or speech impaired users) can call 1-866-605-1277.

Service in Puerto Rico

Panasonic Puerto Rico, Inc.

San Gabriel Industrial Park, Ave. 65 de Infantería, Km. 9.5,

Carolina, Puerto Rico 00985

Phone (787)750-4300, Fax (787)768-2910

Index

- 2 2-way recording: 40
- A** AC adaptor, connecting: 12
- Adding another phone: 100
- Additional handsets
 - Registering: 25
- Adjusting
 - Base unit handset volume: 29
 - Cordless handset receiver volume:
 - 31
 - Headset volume: 29, 31
 - Ringer pattern: 80
 - Ringer volume: 80
 - Speaker volume: 29, 31
- Alerting your cell phone/paging device: 86
- Answering calls: 32
- Answering system: 71
 - Changing the greeting: 72
 - Erasing a greeting message: 73
 - Number of rings: 71
 - Recording a greeting message: 72
 - Selecting greeting message: 72
 - Selecting pre-recorded message: 72
 - Turning off: 73
 - Turning on: 71
- Automated attendant system
 - Calling: 66
 - Changing a recorded greeting: 67
 - Changing the greeting: 67
 - Erasing a greeting message: 68
 - Recording a greeting message: 67
 - Selecting a recorded greeting: 67
 - Setting: 67
 - Turning off: 68
 - Turning on: 67
- Auto message delete: 88
- Auto talk: 33, 81
- B** Backlit display: 23
- Backup battery
 - Installing: 11
 - Replacing: 97
- Base unit: 18
- Battery indicator: 11
- Controls: 18-20
- Display: 23
- Handset volume: 29
- Initializing: 77
- Installing backup battery: 11
- Location: 9
- Navigator key: 22
- Programming: 74
- Battery, cordless handset. See Cordless handset battery
- Battery indicator: 11
- Battery installation
 - Backup battery: 11
 - Cordless handset: 16
- Belt clip: 99
- C** Caller ID edit: 82
 - Auto edit: 49
- Caller ID service: 47
- Caller list: 48
 - Automatically editing a number: 49
 - Calling back caller: 48
 - Clearing: 78
 - Editing number before calling back:
 - 49
 - Erasing: 50
 - Storing caller information in
 - Phonebook: 50
 - Viewing: 48
- Calling
 - automated attendant system: 66
 - caller who left a voice mail message:
 - 54, 56
- Calling back from caller list: 48
- Call operator status: 70
- Call privacy: 39

- Calls
 - Answering: 32
 - Conferencing: 38
 - Joining in conversation: 39
 - Making: 28
 - Monitoring: 86
 - Placing on hold: 37
 - Restricting: 85
 - Screening: 86
 - Swapping between: 37
 - Transferring: 36
 - Call waiting
 - Caller ID display: 41
 - Service: 41
 - Tone: 41
 - Canceling call restriction: 86
 - Capabilities: 10
 - Cell phone, alerting: 86
 - Chain dialing: 46
 - Changing
 - Cordless handset name: 83
 - Recorded greeting message: 67
 - Character table: 44
 - Charger: 21
 - Wall mounting: 96
 - Clearing
 - Caller list: 78
 - Phonebook: 78
 - Redial list: 79
 - Settings: 77
 - Conference calls: 38
 - Connecting
 - AC adaptor: 12
 - AC adaptor to charger: 15
 - Another phone: 100
 - Base unit handset: 12
 - Telephone line cords: 13
 - Controls
 - Base unit: 18-20
 - Cordless handset: 21
 - Conversations
 - Handsfree: 29, 31
 - Joining in: 39
 - Muting: 40
 - Recording: 40
 - Cordless handset: 21
 - Answer mode on/off: 62
 - Battery charge: 16
 - Changing name: 83
 - Controls: 21
 - De-registering: 27
 - Display: 23
 - Initializing: 77
 - Installing battery: 16
 - Joystick: 22
 - Key tones: 90
 - Lighted keypad: 31
 - Programming: 76
 - Registering: 25
 - Setting mailbox password: 52
 - Softkeys: 21
 - Volume: 31
 - Cordless handset battery
 - Charging: 16
 - Installing: 16
 - Performance: 17
 - Replacing: 97
 - Strength: 17
 - Creating voice mail messages: 57
 - Customer services directory: 119
 - Customer support: 92
- D**
- Date and time, setting: 24
 - Delivering voice mail messages: 57
 - De-registering a handset: 27
 - Dialing mode: 25
 - Direct commands: 93
 - Direct handset access: 52
 - Display
 - Backlit: 23
 - Base unit: 23
 - Contrast: 83
 - Cordless handset: 23
 - Error messages: 101
 - Language: 24
- E**
- Editing Phonebook entries: 45
 - Environment: 9
 - Erasing
 - Caller information: 50
 - Greeting message: 68, 73, 79
 - Incoming messages: 79
 - Mailbox messages: 59
 - Messages automatically: 88
 - Music on hold: 90
 - Phonebook item: 46
 - Voice mail messages: 54, 56
 - Error messages: 101

- F** FAQs: 110
 - Finding Phonebook item: 44
 - FLASH key: 41
 - Flash time: 84
 - Frequently asked questions: 110
- G** General delivery mailbox: 52
 - Erasing messages: 54
 - Listening to messages: 56
 - Setting password: 51
 - Transferring messages: 54Greeting messages
 - Changing: 67, 73
 - Erasing: 68, 73
 - Personal: 60
 - Pre-recorded: 67, 72
 - Recording: 67, 72
 - Selecting: 67, 72-73
 - User: 60
- H** Handset (base unit)
 - Connecting: 12Handsfree conversation: 29, 31Headset
 - optional: 98
 - Volume (base unit): 29
 - Volume (cordless handset): 31Hold: 37
- I** Indicators
 - Battery: 11, 17Initializing: 77Installing
 - Backup battery in base unit: 11
 - Cordless handset battery: 16Intercom calls: 35
- J** Joining in a conversation: 39Joystick, cordless handset: 22
- K** Key tone: 90
- L** Language, setting: 24Last number redial: 29, 32LCD contrast: 83Line mode: 25Listening to messages: 52, 55Listening to voice mail messages: 52, 55Location of controls: 18-21
- M** Mailbox
 - Checking password: 52
 - Password: 51
 - Setting cordless handset password: 52
 - Setting general delivery password: 51Mailbox password
 - Checking: 52Making calls: 28Message alert: 86Messages
 - Checking remaining recording time: 59
 - Creating: 57
 - Deleting automatically: 88
 - Erasing: 59
 - Listening to: 52, 54
 - Sending: 57
 - Setting alert: 86
 - Transferring: 54, 56Microphone: 29, 31, 33Modes
 - Dialing: 25
 - Line: 25MOH. See Music on holdMonitoring calls: 86Music on hold: 88Muting: 40
- N** Navigator key
 - Base unit: 22
 - Cordless handset: 22Noise: 9Number of rings before answering system answers: 71
- P** Paging device, alerting: 86Passwords
 - Setting cordless handset mailbox: 52
 - Setting general delivery mailbox: 51PAUSE key: 41Personal greetings: 60Personalized name display: 47Personal mailbox password: 52Phonebook
 - Chain dialing: 46
 - Character table: 44
 - Clearing: 78
 - Dialing from: 44
 - Editing items: 45
 - Erasing items: 46
 - Searching: 44
 - Storing names and numbers: 43, 50Power failure: 11Privacy: 39Programming
 - Base unit: 74
 - Cordless handset: 76
 - Direct commands: 93Pulse dialing: 25

- R** Receiver volume: 31
- Recording
 - Checking remaining time: 59
 - Conversations: 40
 - Greeting messages: 67, 72
 - Music on hold: 89
- Redial: 29, 32
- Redial list: 30, 32
 - Clearing: 79
- Registering additional handsets: 25
- Replacing
 - Backup battery: 97
 - Handset battery: 97
- Re-registering handset: 90
- Reset button: 100
- Restricting calls: 85
- Ringer
 - Off: 33-34, 80
 - Pattern: 80
 - Volume: 80
- Ring group: 82
- Rotary dialing: 25, 42
- Routine care: 9
- S** Safety instructions: 7
- Screening calls: 86
- Searching Phonebook: 44
- Selecting
 - Greeting message: 72
 - Pre-recorded greeting message: 67, 72
 - Recorded greeting message: 67, 72-73
- Setting
 - Automated attendant system: 67
 - Date and time: 24
 - Direct handset access: 52
 - Display language: 24
- Setting-up
 - Mailbox: 51
 - Telephone line: 13, 85
- Softkeys: 21
- Speaker volume: 31
- Specifications: 117
- Speed dial
 - Dialing: 30, 32
 - Storing: 91
- SP-phone: 29, 31, 33
- Storing
 - Caller Information in Phonebook: 50
 - Phonebook entries: 43
 - Speed dial numbers: 91
- Swapping between calls: 37
- System capabilities: 10
- T** Telephone line
 - Setting-up: 13, 85
- Temporary tone dialing: 42
- Time
 - Adjusting automatically: 90
 - Setting date and time: 24
- Tone dialing: 25
 - Temporary: 42
- Transferring
 - Calls: 36
 - Calls to mailboxes: 58
 - Voice mail messages: 54, 56
- Transferring messages: 54, 56
- Troubleshooting
 - Answering systems: 109
 - Auto attendant: 109
 - Battery recharge: 108
 - Caller ID: 107
 - General use: 104
 - Making/answering calls: 105
 - Paging: 105
 - Phonebook: 106
 - Programmable settings: 105
 - Voice mail: 109
- TTY users: 5
- Turning off
 - Answering system: 73
 - Automated attendant system: 68
 - Music on hold: 88
- Turning on
 - Answering system: 71
 - Automated attendant system: 67
 - Music on hold: 88
- U** User greetings: 60
- V** Viewing callers in caller list: 48

Voice mail: 51

- Calling back a caller: 54, 56
- Checking number of messages: 59
- Checking remaining time: 59
- Creating messages: 57
- Delivering messages: 57
- Erasing messages: 54, 56
- Error messages: 103
- General delivery mailbox: 52
- Listening to general delivery messages: 56
- Listening to messages: 52, 55
- Listening to personal messages: 54
- Password: 51
- Personal greetings: 60
- Personal mailbox: 54
- Sending messages: 57
- Setting-up: 51
- Transferring calls to: 58
- Transferring messages: 54, 56
- User greetings: 60

Volume

- Base unit: 29
- Cordless handset: 31
- Ringer: 80

- W** Wall mounting the charger: 96
Warranty: 117

If you need assistance with setup or operation;

- 1** Visit our website: <http://www.panasonic.com/phonehelp>
- 2** Contact us via the web at: <http://www.panasonic.com/contactinfo>
- 3** Call us at: 1-800-211-PANA (1-800-211-7262)
TTY users (hearing or speech impaired users) can call 1-877-833-8855.

When you ship the product;

- Carefully pack your unit, preferably in the original carton.
- Attach a letter, detailing the symptom, to the outside of the carton.
- Send the unit to Panasonic Services Company Customer Servicer, prepaid and adequately insured.
- Do not send your unit to Panasonic Consumer Electronics Company listed below or to executive or regional sales offices. These locations do not repair consumer products.

- This product is designed for use in the United States of America. Sale or use of this product in other countries may violate local laws.
- Cet appareil est conçu pour être utilisé aux États-Unis d'Amérique. La vente ou l'emploi de cet appareil dans certains autres pays peut constituer une infraction à la législation locale.
- Este producto está diseñado para usarse en los Estados Unidos de América. La venta o el empleo de este producto en ciertos países puede constituir violación de la legislación local.
- 本產品專為美國使用而設。若在其他國家銷售或使用，可能會違反當地法例。
- この製品は、日本国外での使用を目的として設計されており、日本国内での使用は法律違反となります。従って、当社では日本国内においては原則として修理などのサービスは致しかねます。

Copyright:

This material is copyrighted by Panasonic Communications Co. (U.K.) Ltd., and may be reproduced for internal use only. All other reproduction, in whole or in part, is prohibited without the written consent of Panasonic Communications Co. (U.K.) Ltd.

© 2006 Panasonic Communications Co. (U.K.) Ltd. All Rights Reserved.

Panasonic Consumer Electronics Company, Division of Panasonic Corporation of North America

One Panasonic Way, Secaucus, New Jersey 07094

Panasonic Puerto Rico, Inc.

San Gabriel Industrial Park, Ave. 65 de Infantería, Km. 9.5,
Carolina, Puerto Rico 00985